

Includes hundreds of deck plan drawing symbols and room layouts used in creating the Starship Geomorphs book. Use as inspiration to create your own unique starship, space station, starport, or building designs.

Ideal for creating custom plans printed for use with miniatures or capturing images for use with virtual table top systems.

Starship Symbols

TRAVELLER
*Science-Fiction Adventure
in the Far Future*

Introduction

This book is a collection of the many symbols and room blocks that were created while making the Starships Geomorph book. Since not all drawings in that book were made into blocks, this book will not contain everything included in the geomorphs book. However, I have also included a few never before seen spaces - mostly Bridges and Engineering for additional variety.

How to use this book

While the geomorphs were created to assist gamers by providing a quick deck plan solution to their needs, they are not - nor were they intended to be - a substitute for real starship design per the Traveller rules. I decided to make these symbols available to the more um... "*artistically challenged*" starship designers as a shortcut to help them realize their designs. The added benefit is that those who want to just print out parts for use with miniatures or virtual tabletop systems can do so.

For the CAD monkeys out there (I'm not using that term derogatorily - I am one of you!) I am also making an AutoCAD .DWG file of the symbols available, as well as the .CTB file for lineweight settings. The more ambitious should be able to create their own starship deck plans or geomorphs in my drawing style with little difficulty.

For those with the inclination to make images for use with virtual table top systems, permission is granted to copy and share as you like so long as it is for non-commercial purposes. Proper credit and links to my blog are appreciated. (www.travellerrpgblog.blogspot.com)

Printing for cutouts and miniature use

I'm going to assume anyone interested enough in obtaining this book is already familiar with the Starships Geomorph book. See pages 16 & 17 of the PDF version of that book for ideas on how to print for use as cutouts or for use with miniatures.

>> [Click here](#) to download a free copy of the Starship Geomorphs 2.0 PDF <<

Enjoy!

Starship Symbols

Written and illustrated by Robert Pearce
Release date August 1, 2020.

STARSHIP SYMBOLS

© 2020 Pearce Design Studio, LLC

Table of Contents

Symbols & Abbreviations, 50 Ton Modular Launch	3
Small Craft & Ship's Vehicles	4-6
Airlocks, Vertical Circulation, Barracks	7
Batteries, Computers, Computer Rooms, Armories, Drop Capsules	8
Cargo, Cargo Bays	9
Bridges	10-12
Drives, Machinery, & Equipment	13-18
Engineering	19-21
Fuel Tankage and Related Equipment	22-23
Freshers & Utility Spaces	24
Galley, Mess Halls, and Related Spaces	25
Lounges, Common Areas, and Bars	26
Meeting Rooms, Briefing Rooms, Classrooms	27
Small Hangars, Flight Control Rooms, Workpods	28
Laboratories	29
Laboratories, Ship's Lockers, Storage, and Retail Spaces	30
Medical (Sick Bays) and Low Berth Facilities	31-32
Offices (or Studios)	33-34
Shops and Repair Bays	35
Security Offices, Brigs, Prisoner Cells, Cell Blocks	36
Staterooms and Related Spaces	37-38
Staterooms and Steerage	39
Weaponry	40
50 Ton Bay Weapons, Sensors	41
Miscellaneous Spaces	42
Furniture, Consoles, Equipment	43
Landscape, Agriculture, Robots, & Miscellaneous	44
Empty Rooms, Connecting Corridors	ER1-ER2
Blank Geomorphs	B1-B8

The Legal Stuff

The Traveller game in all forms is owned by Far Future Enterprises. Copyright 1977 - 2020 Far Future Enterprises. Traveller is a registered trademark of Far Future Enterprises. Far Future permits web sites and fanzines for this game, provided it contains this notice, that Far Future is notified, and subject to a withdrawal of permission on 90 days notice. The contents of this document are for personal, non-commercial use only. Any use of Far Future Enterprises's copyrighted material or trademarks anywhere in this document should not be viewed as a challenge to those copyrights or trademarks.

This work is licensed under a Creative Commons Attribution-NonCommercial 4.0 International License.

This work is licensed under a Creative Commons Attribution-NonCommercial 4.0 International License.

Symbols & Abbreviations Quick Reference

Staterooms & Misc Furniture

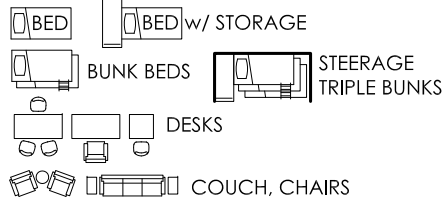

Restroom/bathroom/fresher



General Shipboard

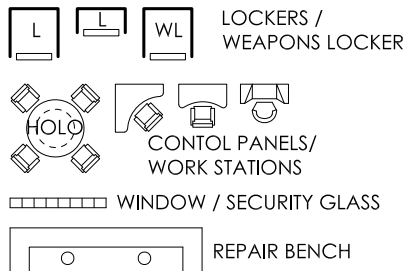

Medical

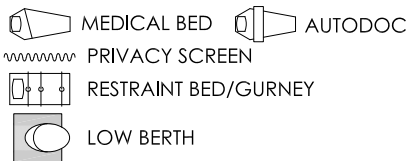

Lounge / Commons Area

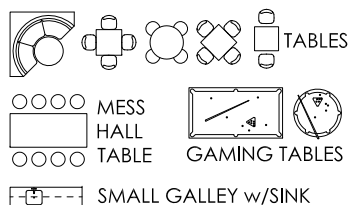

Arboretum / Landscape

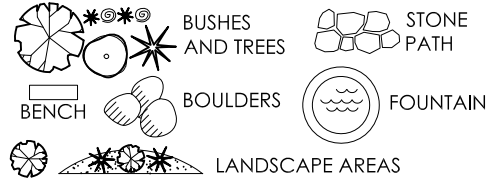

Engineering

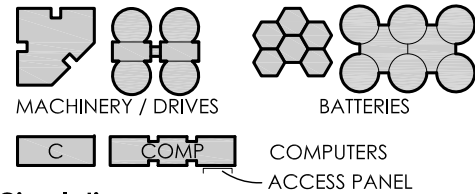

Circulation

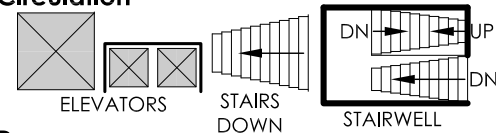

Doors

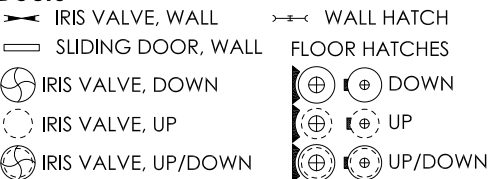

Weapons/Sensors



Cargo

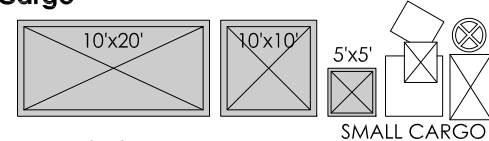

Abbreviations

A/L = AIRLOCK	L = LOCKER
C = COMPUTER	LO = LOUNGE
CH = CHANGING AREA	OFF = OFFICE
COMP = COMPUTER	SH = SHOWER
DBL SR = DOUBLE STATEROOM	SR = STATEROOM
FR = FRESHER	SS = SECURITY STATION
MED = MEDICAL	TS = TECH STATION
MS = MONITORING STATION	WL = WEAPONS LOCKER

Small Craft - 50 Ton Modular Launch

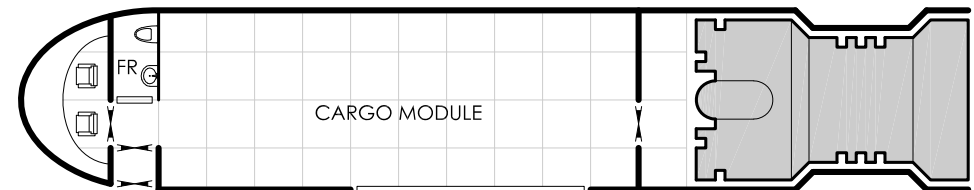
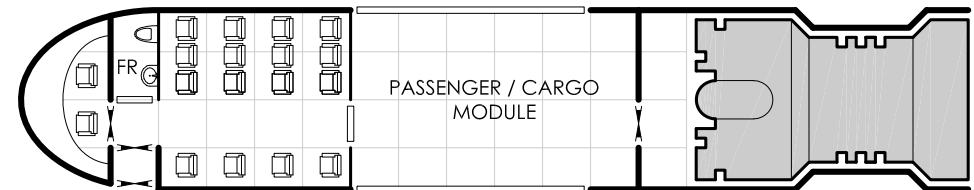
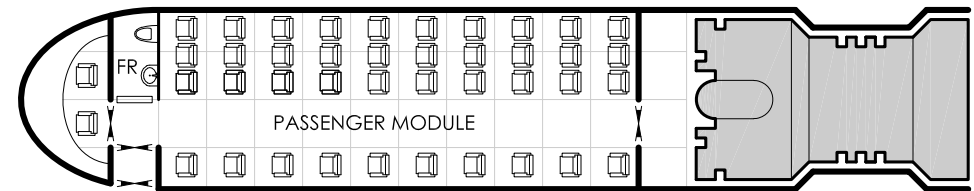
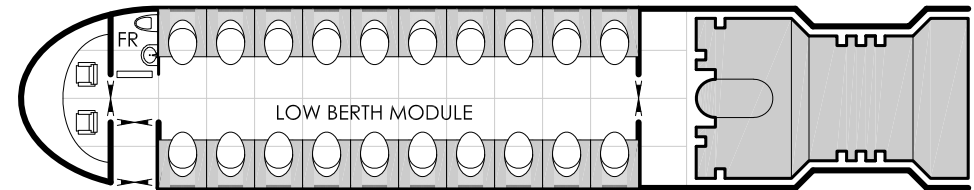
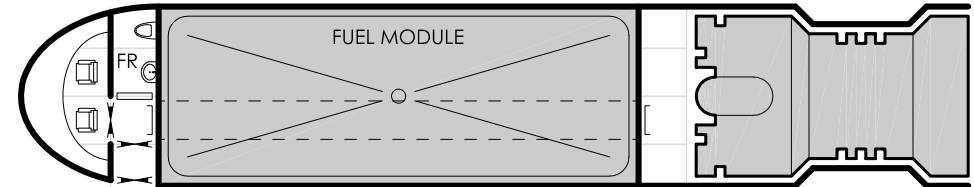
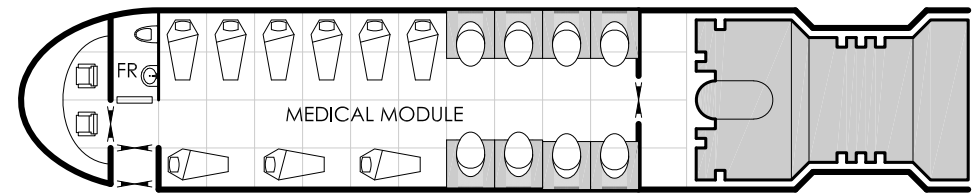

Small Craft & Ship's Vehicles

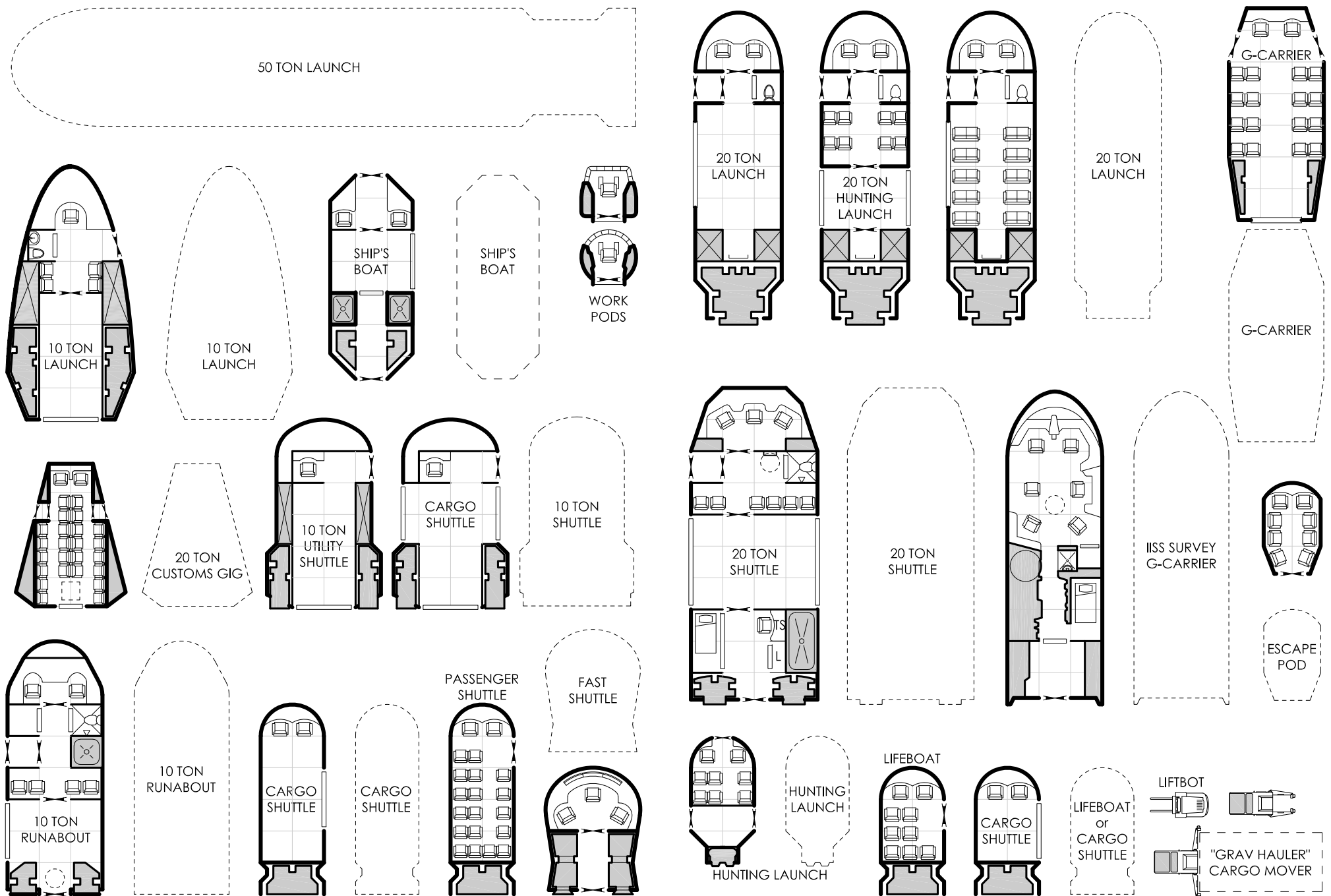

Small Craft & Ship's Vehicles

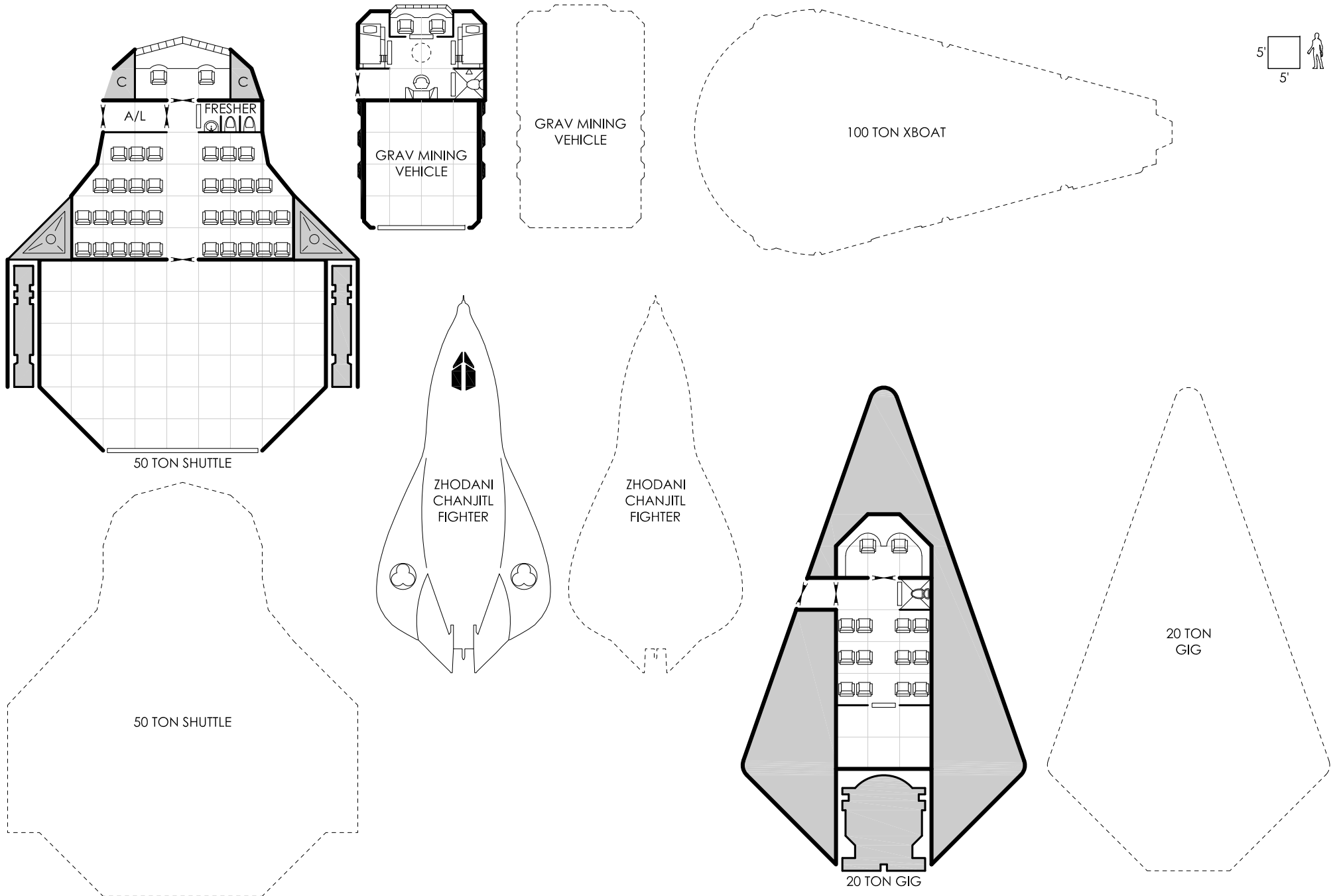

Small Craft & Ship's Vehicles

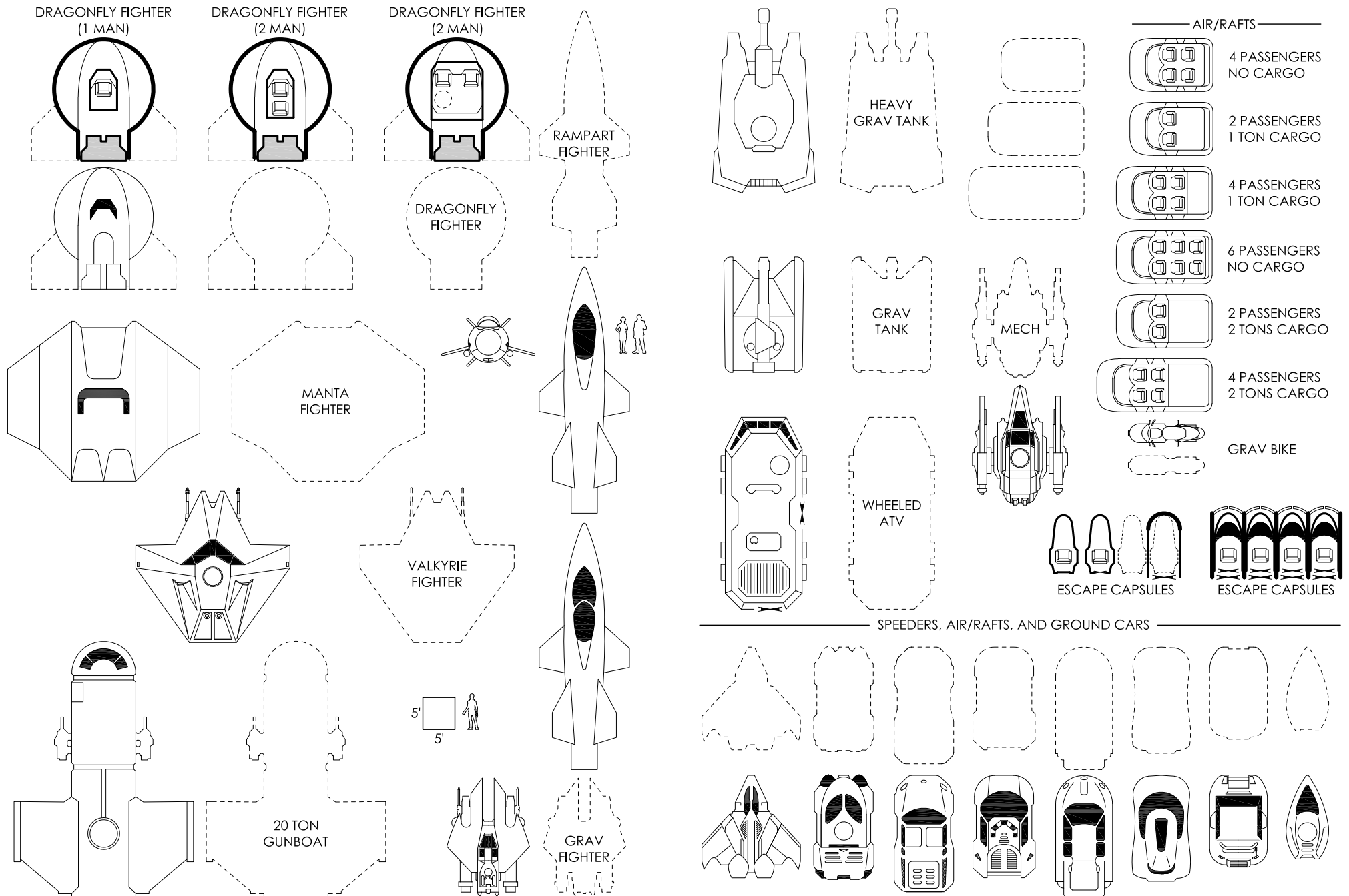

Airlocks, Vertical Circulation

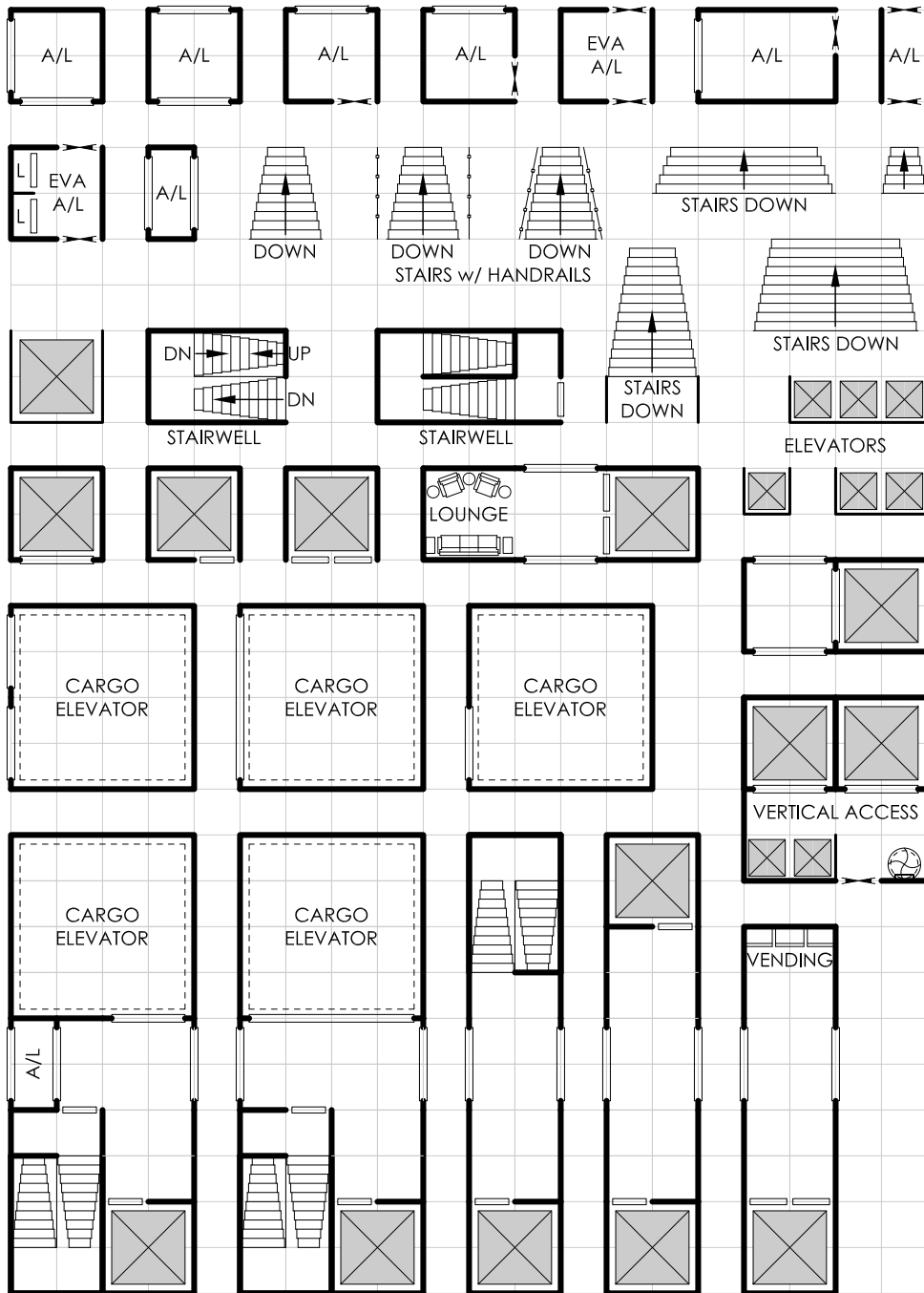

Barracks



Batteries, Computers

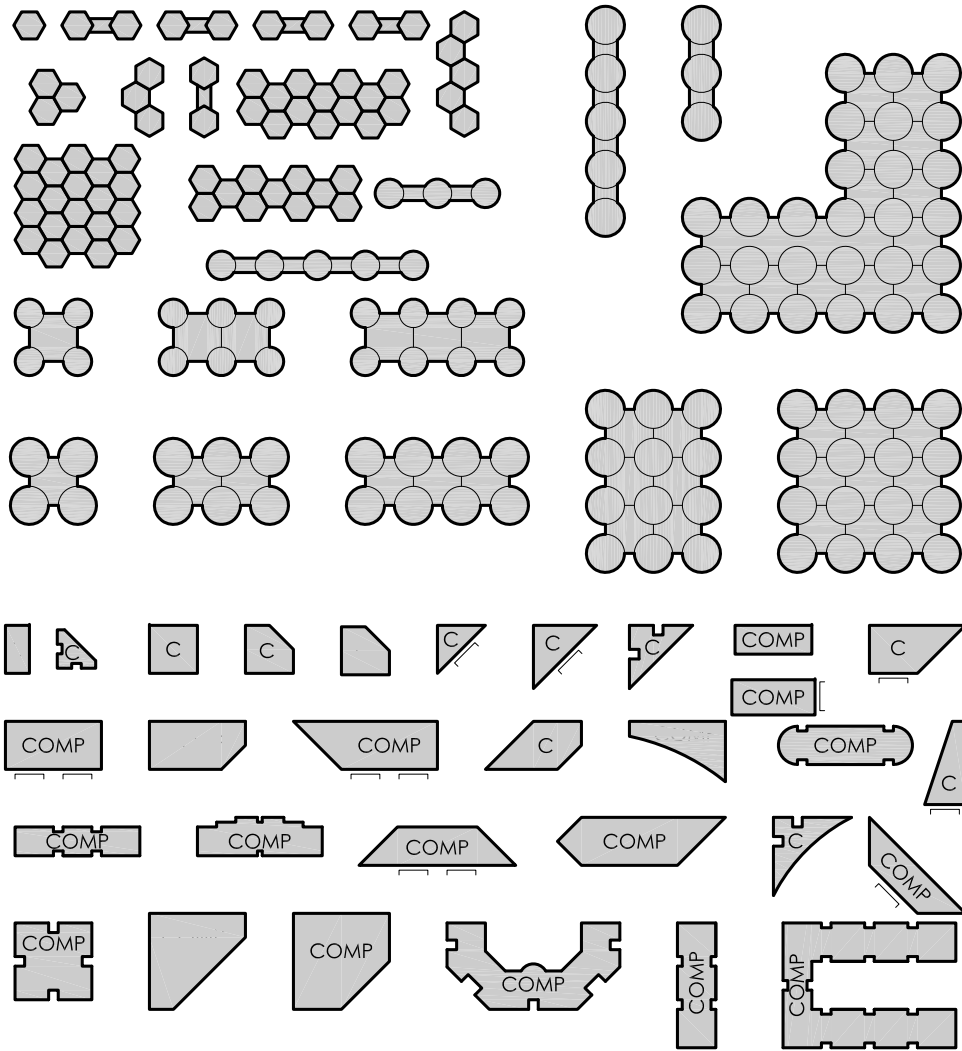

Comp. Rooms, Armories, Drop Capsules

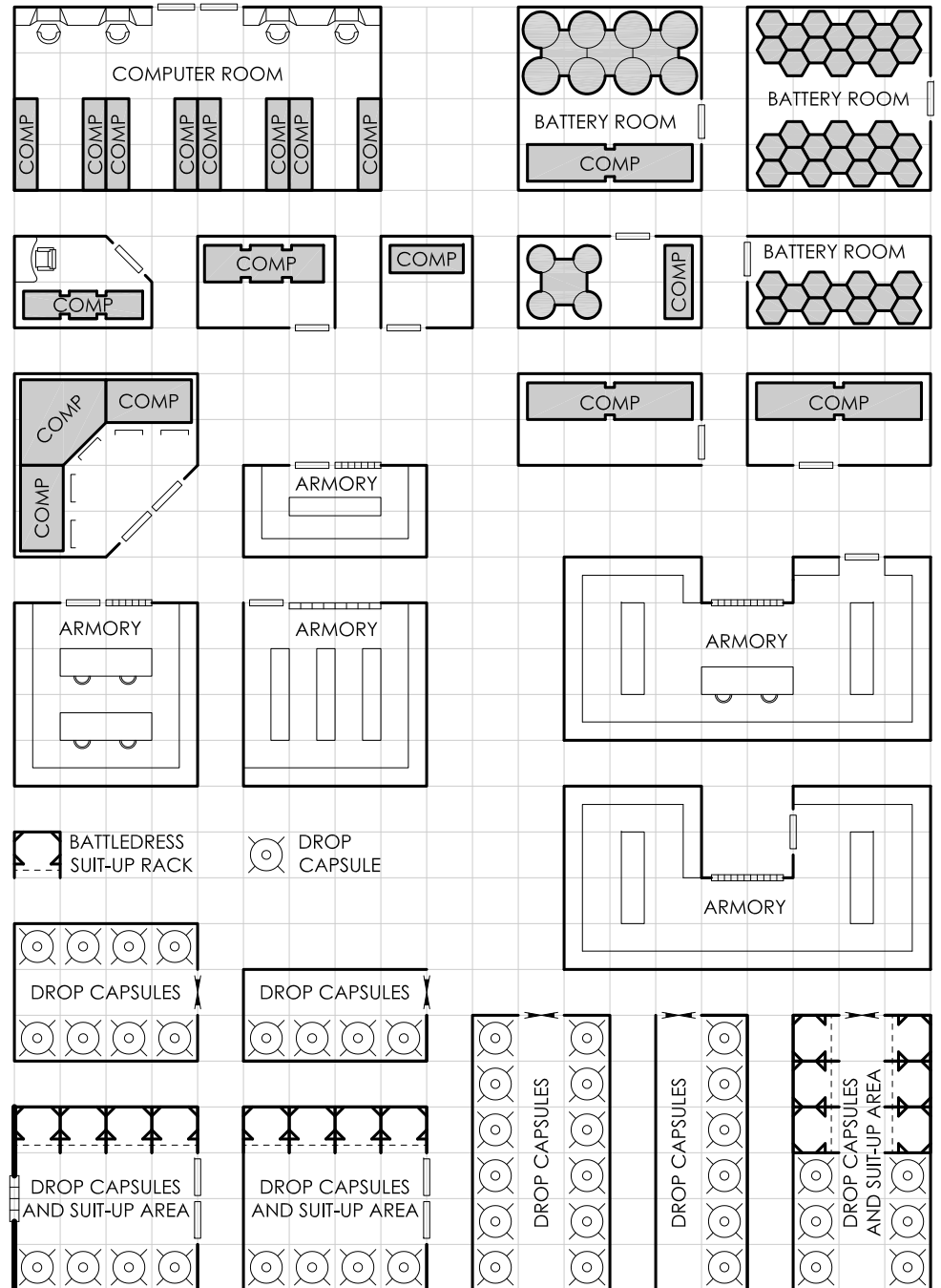

Cargo, Cargo Bays

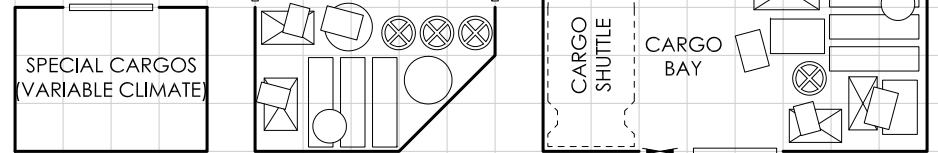
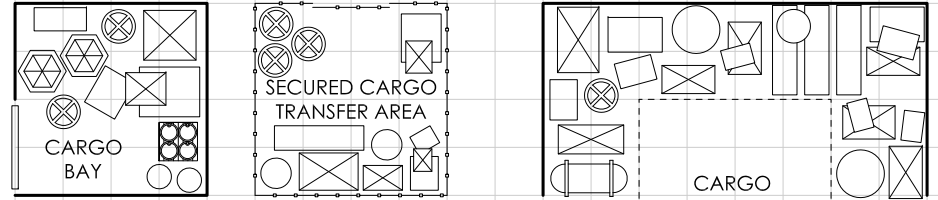
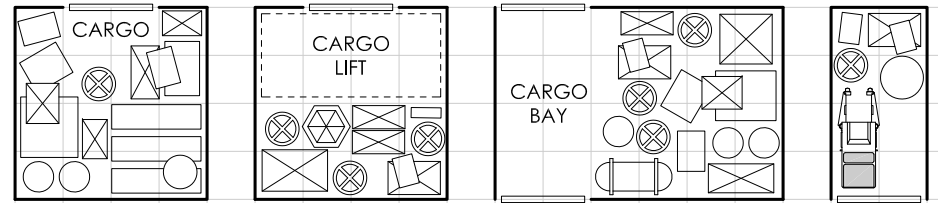
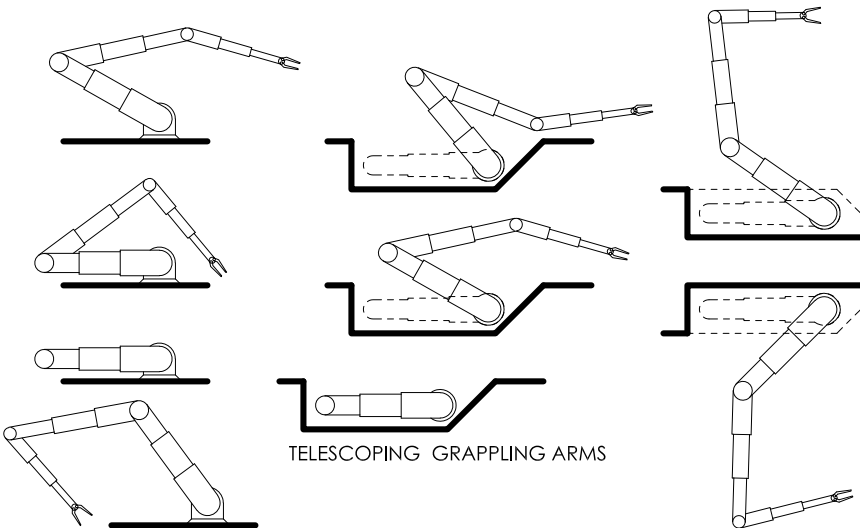
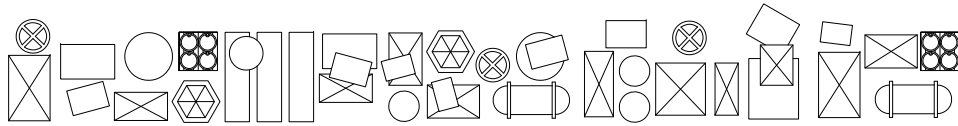

Bridges

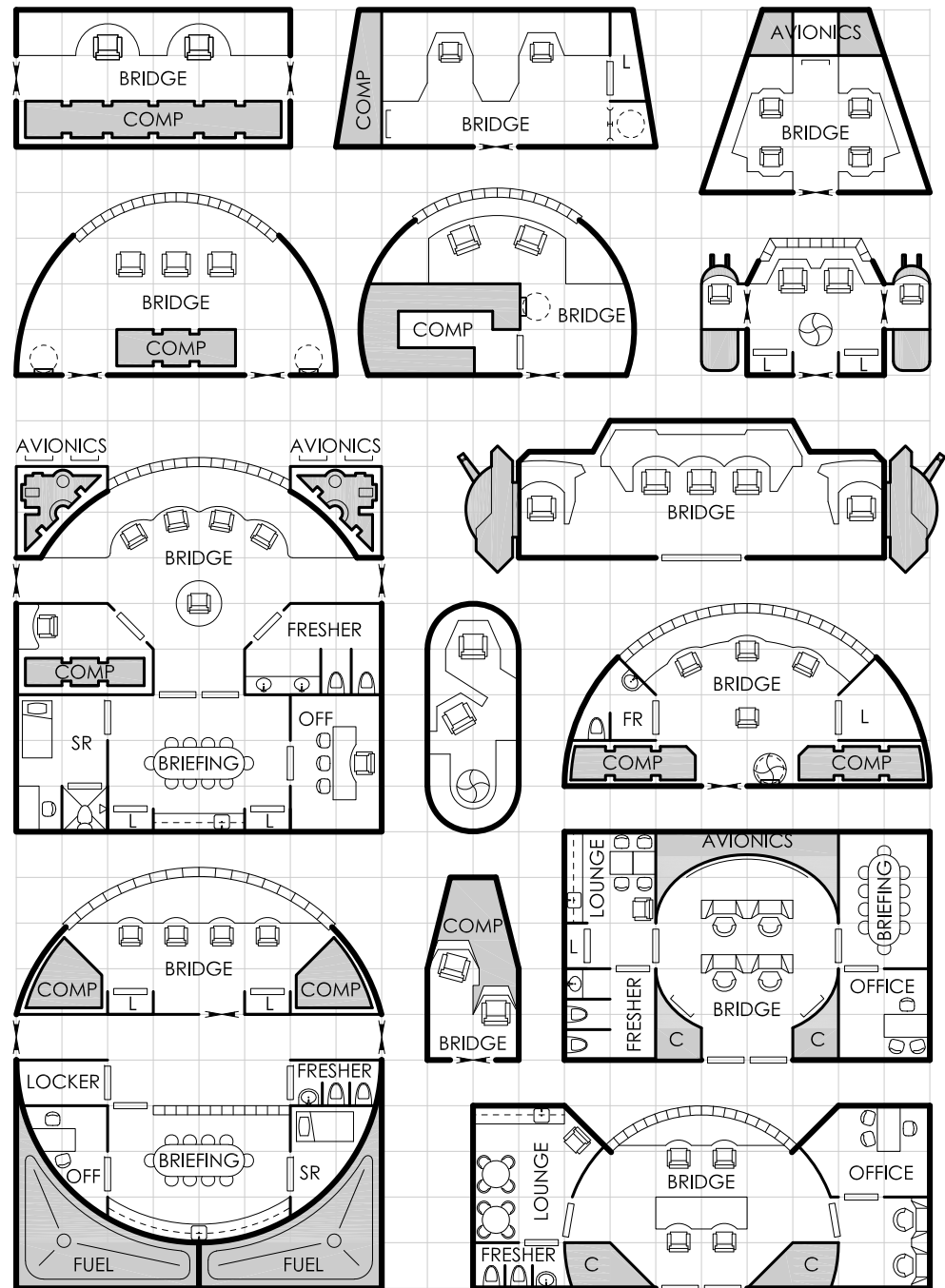
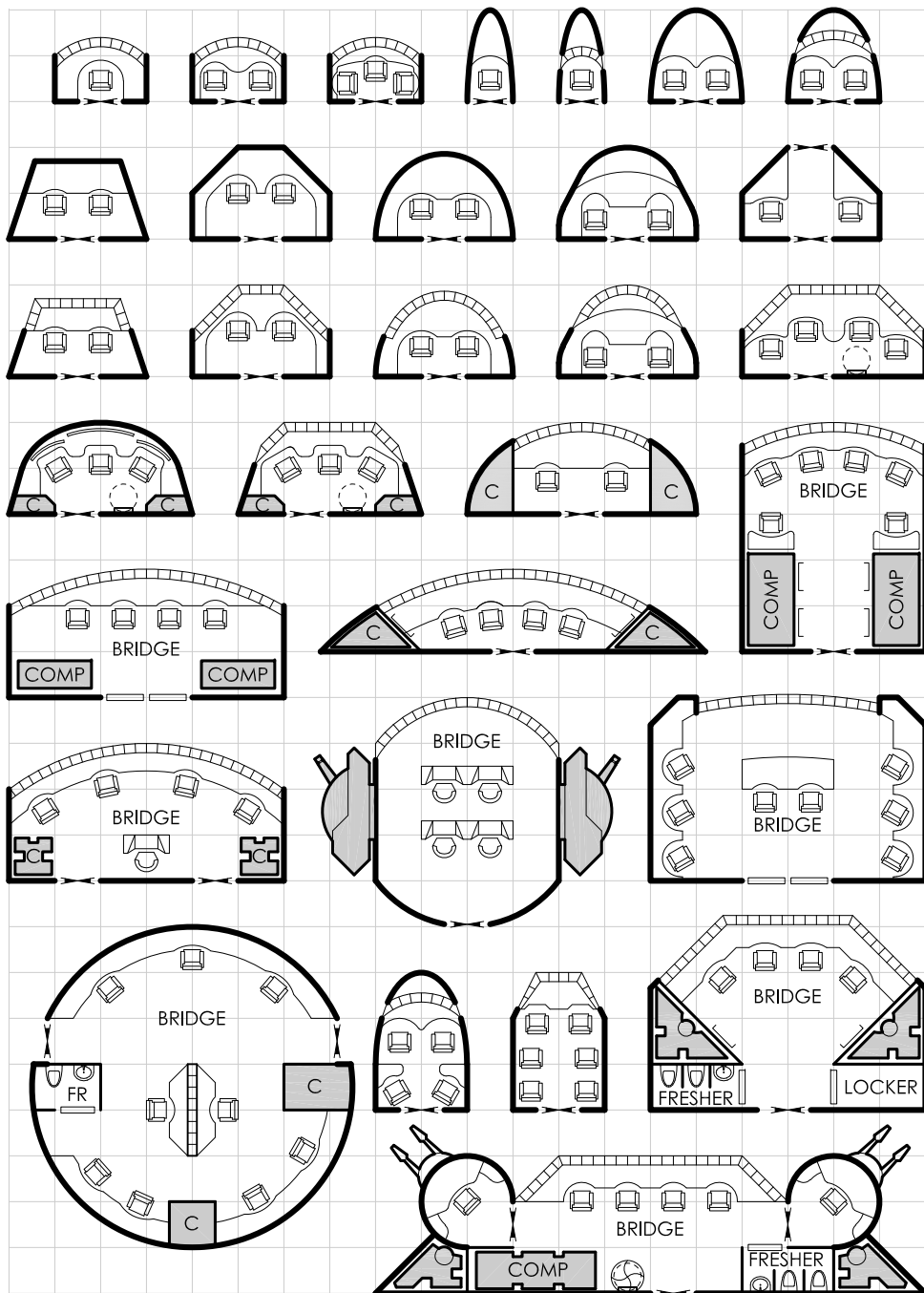

Bridges

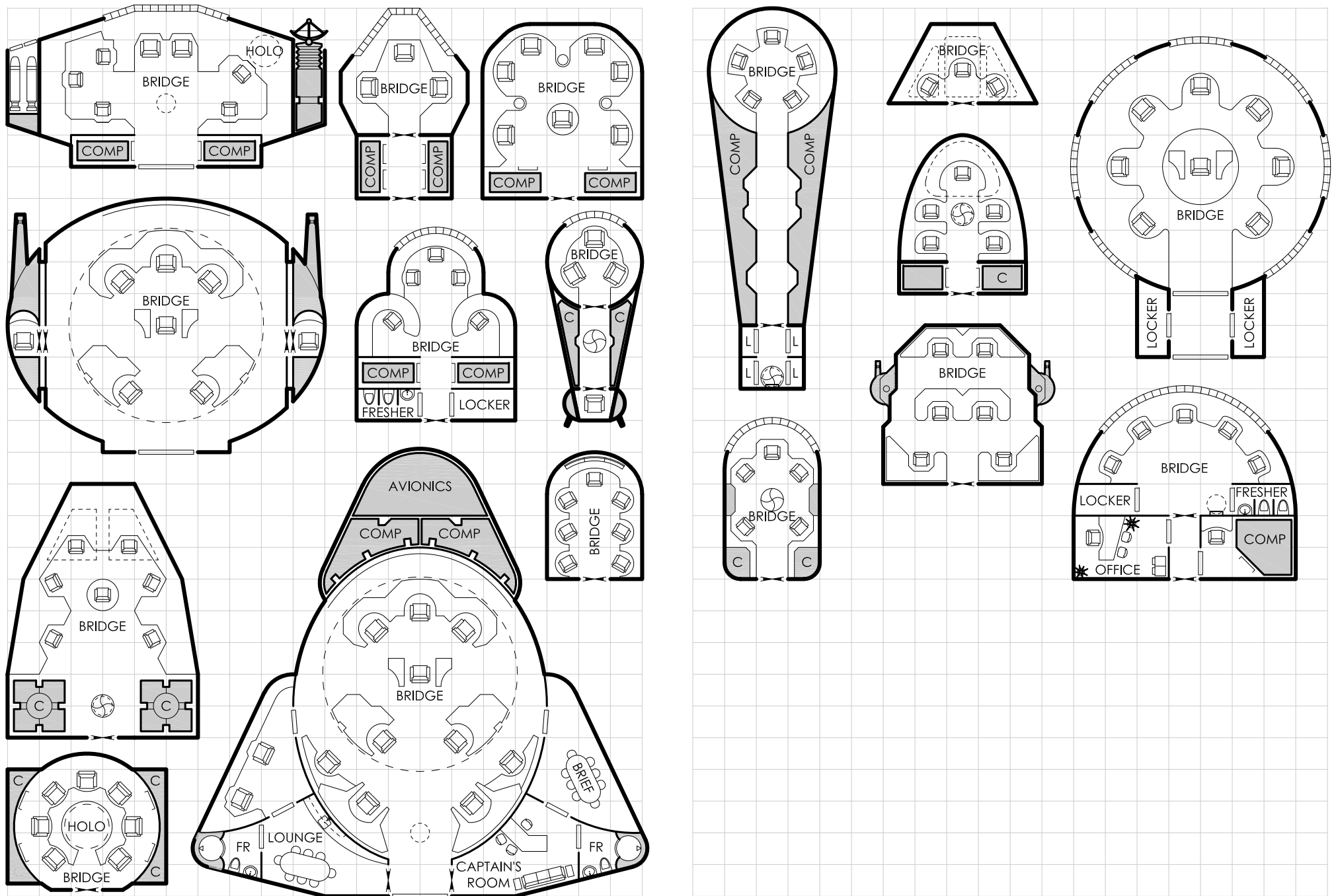

Bridges

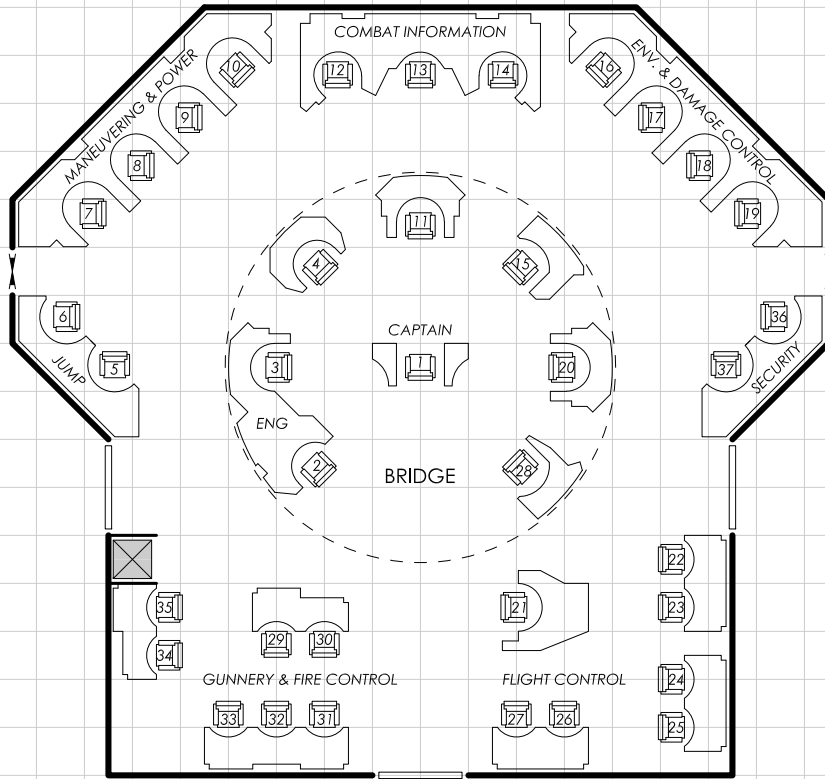

LIGHTING CLASS CRUISER STYLE BRIDGE

COMMAND LOCATIONS:

1. CAPTAIN
2. SUPERNUMERARY STATION

ENGINEERING AND MANEUVERING:

3. CHIEF ENGINEERING OFFICER
4. MANEUVERING OFFICER
5. JUMP DRIVE BRIDGE REPEATERS
6. JUMP CONTROL OFFICER
7. POWER PLANT BRIDGE REPEATERS
8. MANEUVERING DRIVE BRIDGE REPEATERS
9. ASTROGATER
10. HELM

COMBAT INFORMATION CENTER:

11. EXECUTIVE OFFICER
12. ANALYSIS DESK
13. TACTICAL DISPLAY CONTROL
14. PROFILE DESK

ENVIRONMENTAL AND DAMAGE CONTROL:

15. ENVIRONMENTAL CONTROL OFFICER
16. DAMAGE CONTROL - ATMOSPHERIC
17. DAMAGE CONTROL - RADIATION
18. DAMAGE CONTROL - STRUCTURAL
19. DAMAGE CONTROL - SYSTEMIC

FLIGHT CONTROL:

20. FLIGHT CONTROL OFFICER
21. LAUNCH CONTROL OFFICER
22. TO 27. SQUADRON FLIGHT CONTROLLER

GUNNERY AND FIRE CONTROL

28. CHIEF GUNNERY OFFICER
29. AND 30. PRIMARY ENGAGEMENT FIRE DIRECTION OFFICER & ASSISTANT
31. SCREEN AND DAMPER OFFICER
32. CLOSE DEFENSE OFFICER
33. ANTI-MISSILE FIRE COORDINATOR
34. AND 35. SECONDARY ENGAGEMENT FIRE DIRECTION OFFICER & ASSISTANT

SECURITY

36. CHIEF OF SECURITY
37. SECURITY GUARD

Ship's Drives, Machinery, & Equipment

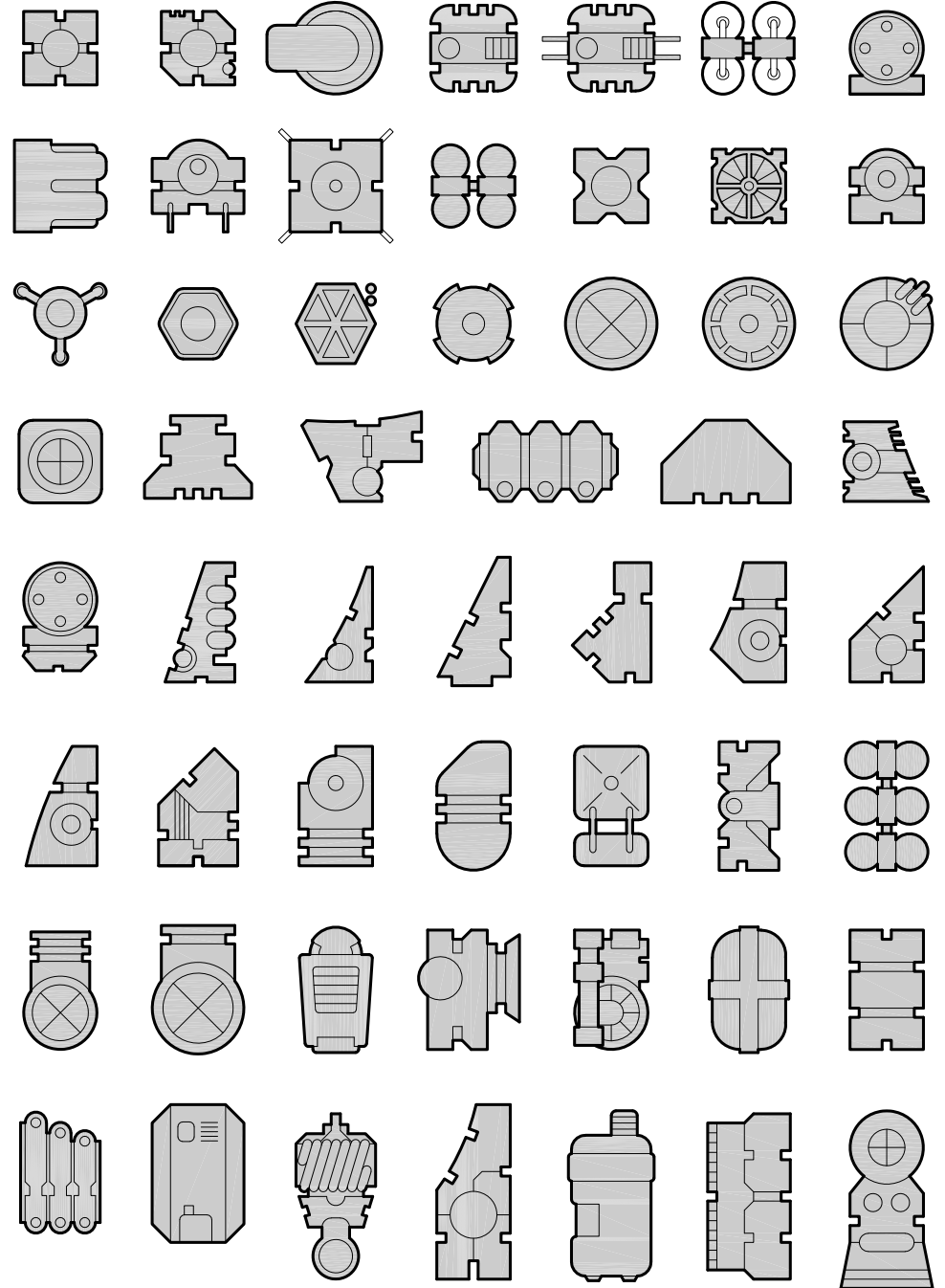
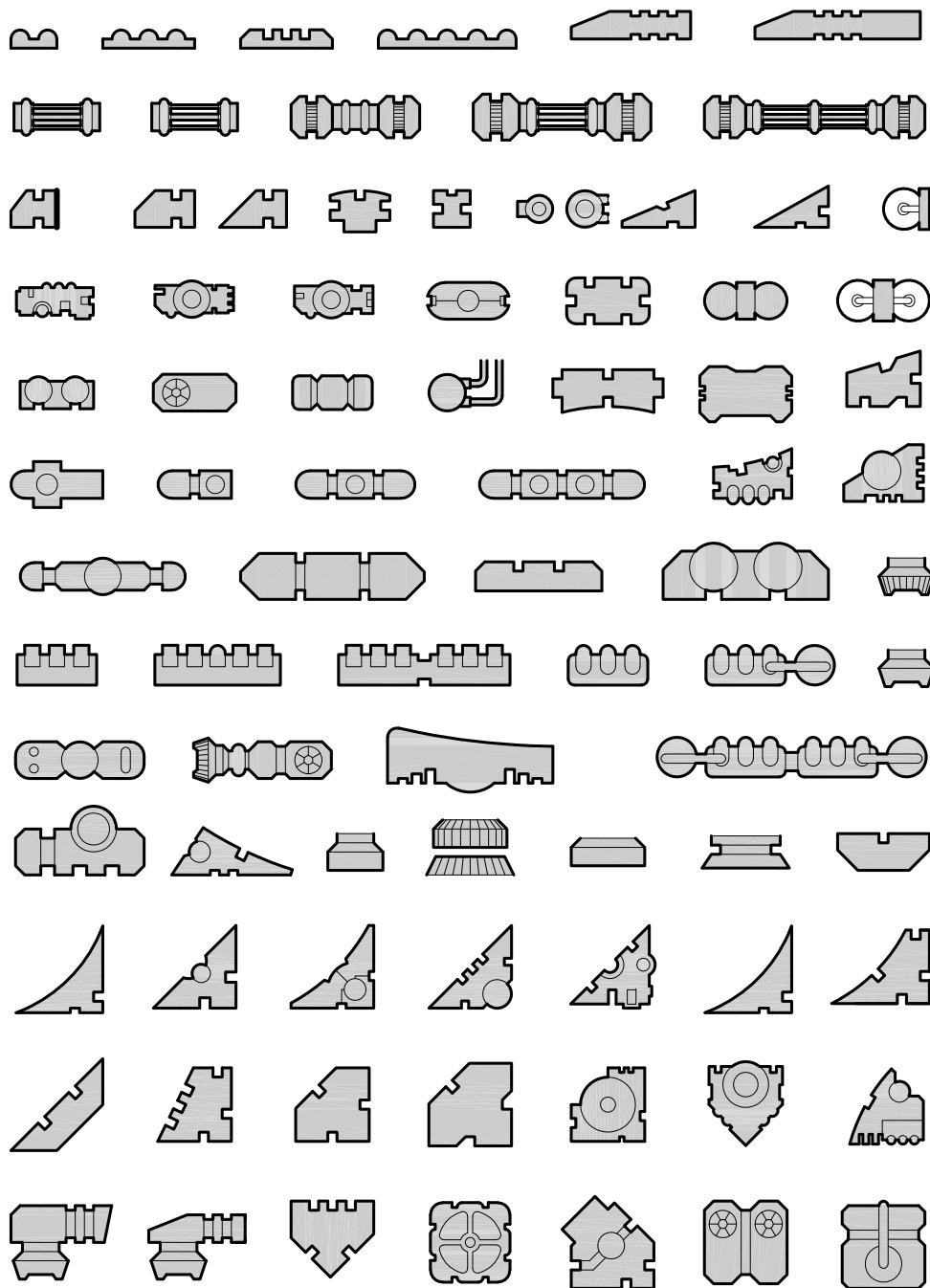

Ship's Drives, Machinery, & Equipment

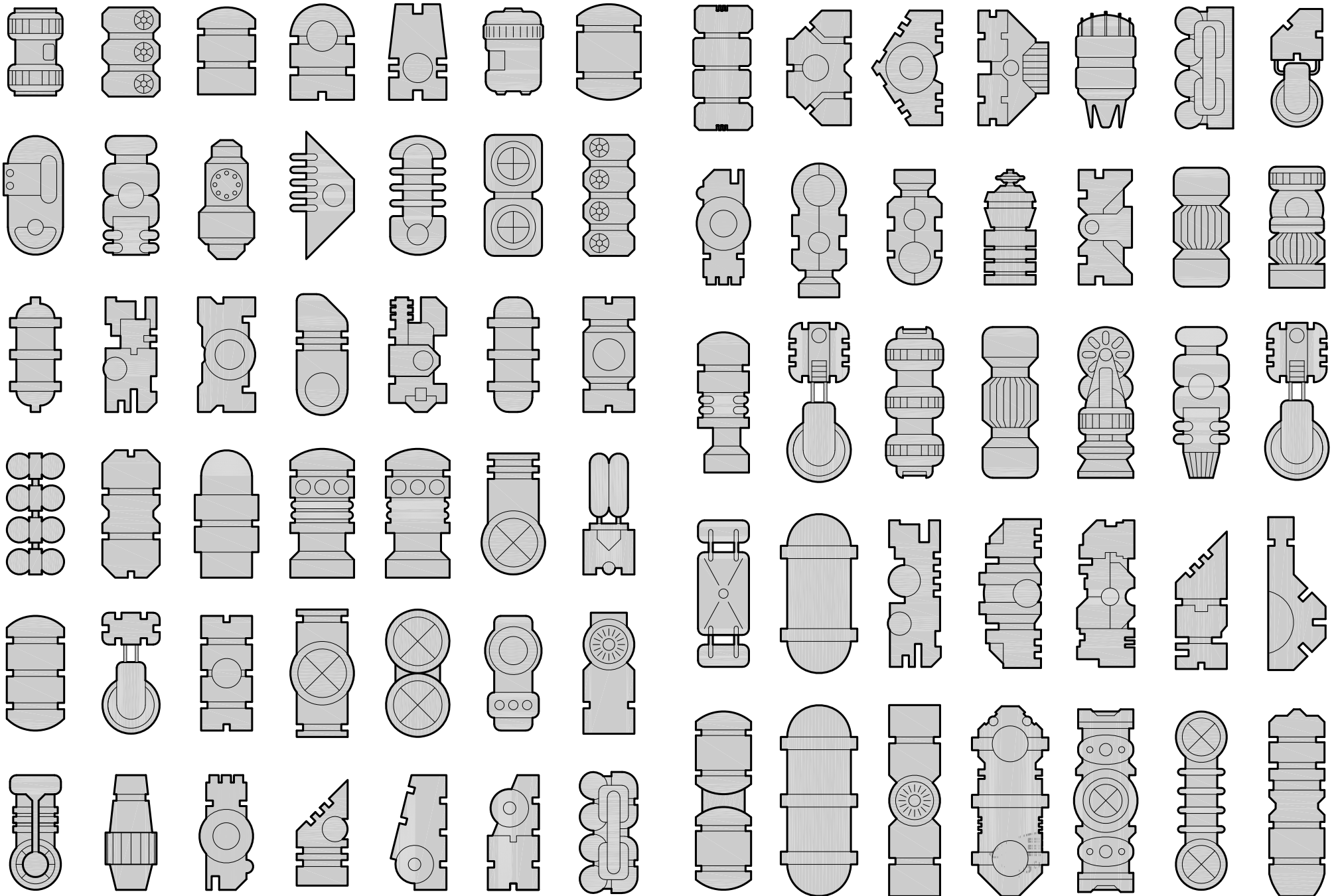

Ship's Drives, Machinery, & Equipment

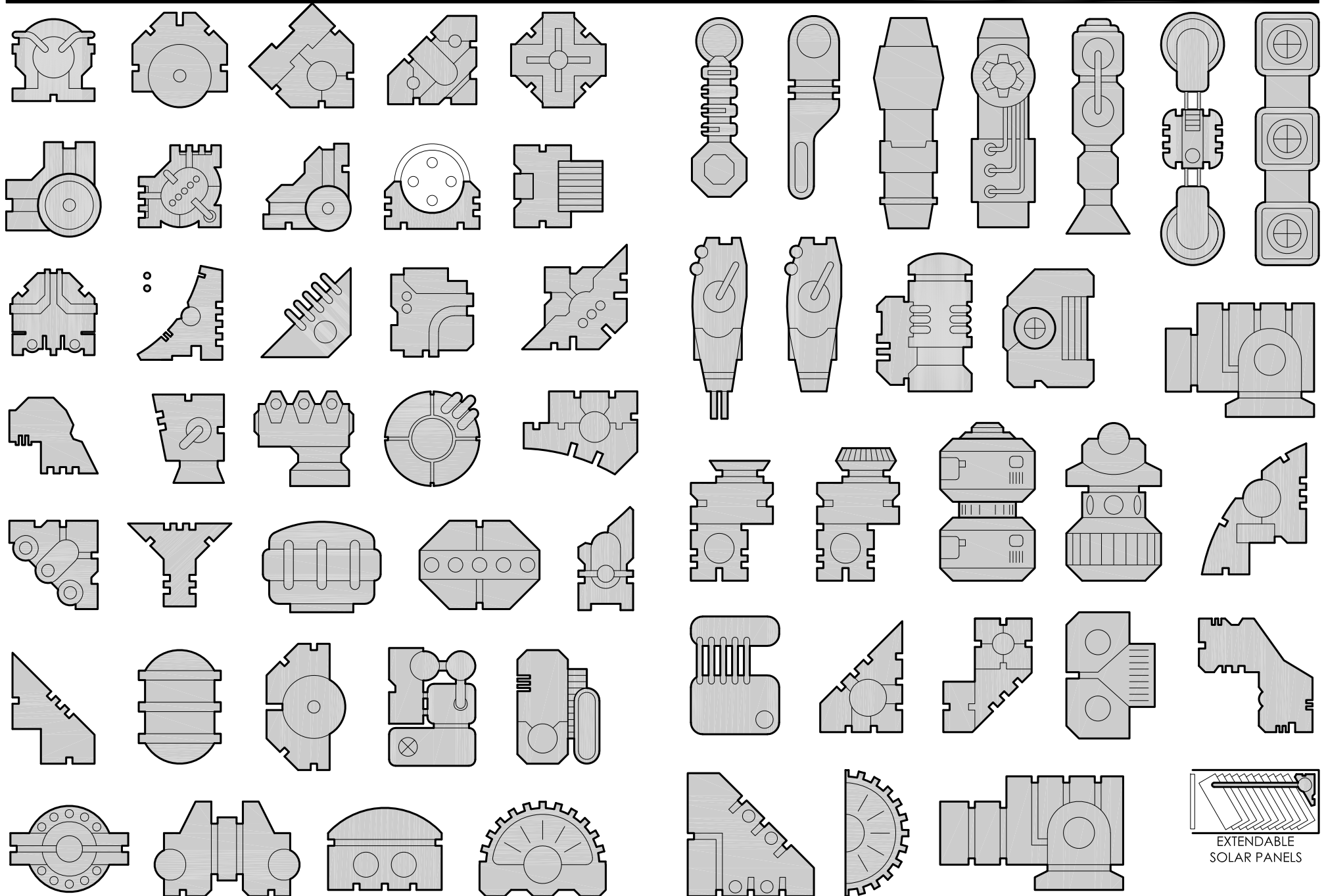

Ship's Drives, Machinery, & Equipment

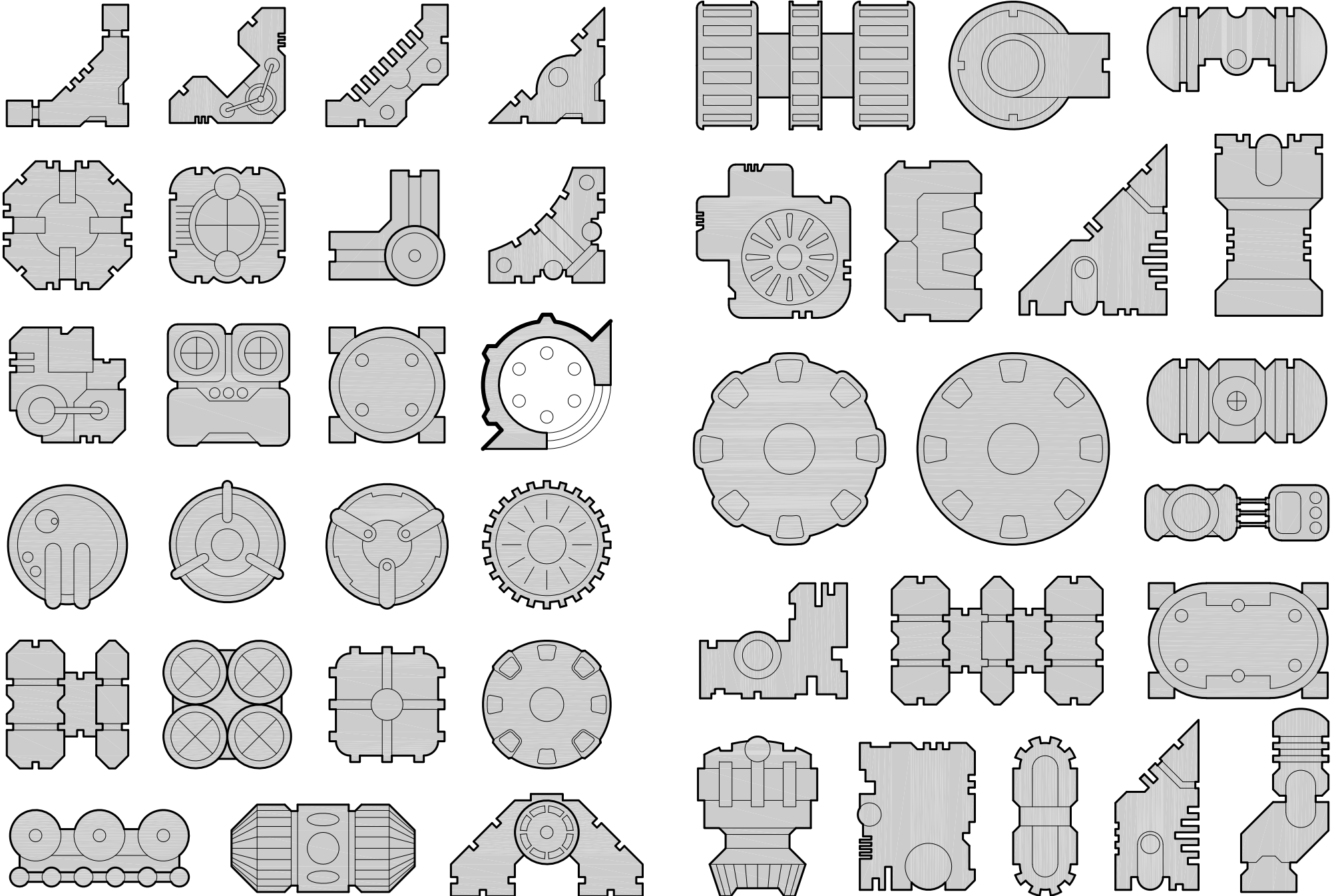

Ship's Drives, Machinery, & Equipment

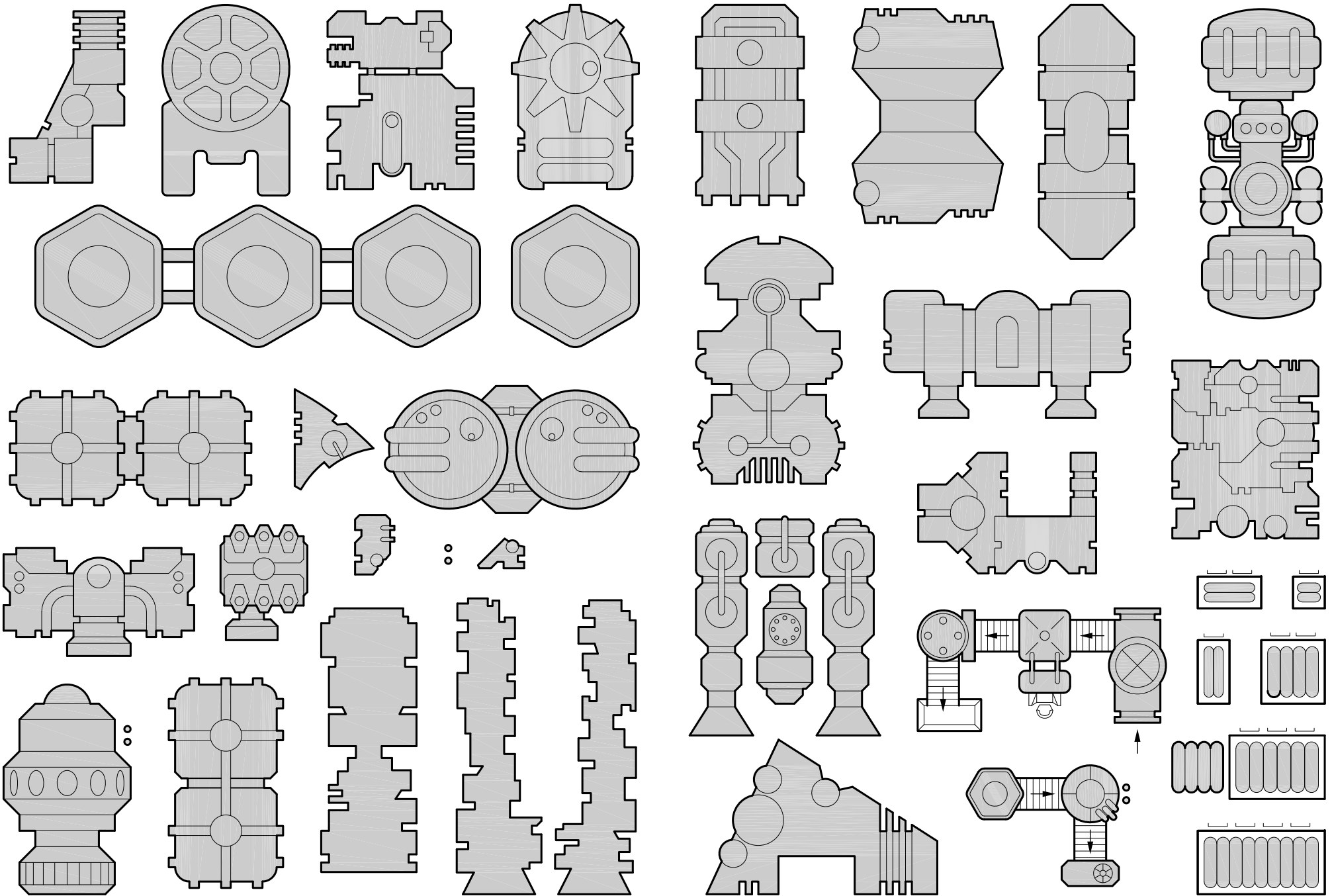

Ship's Drives, Machinery, & Equipment

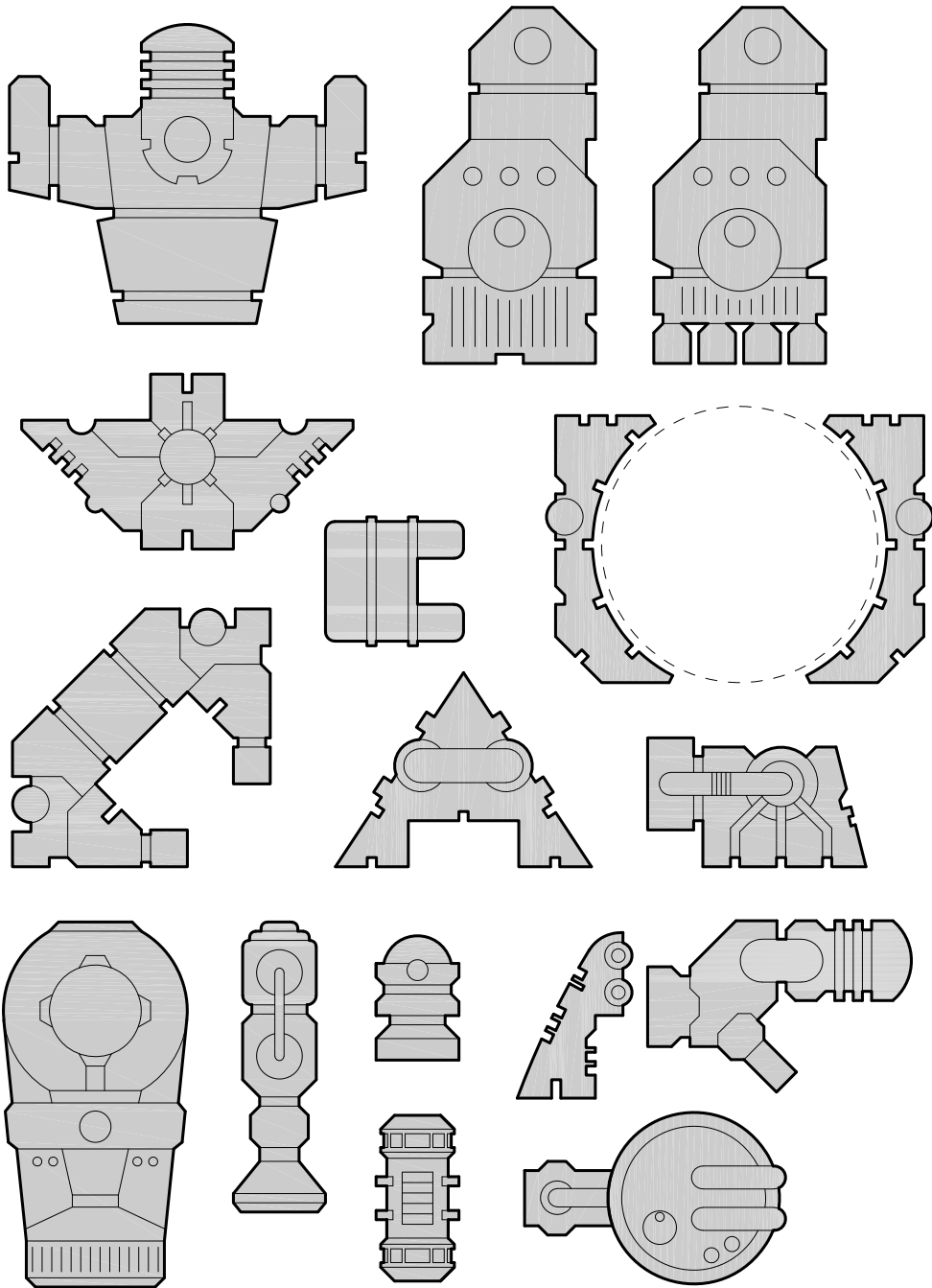

Engineering

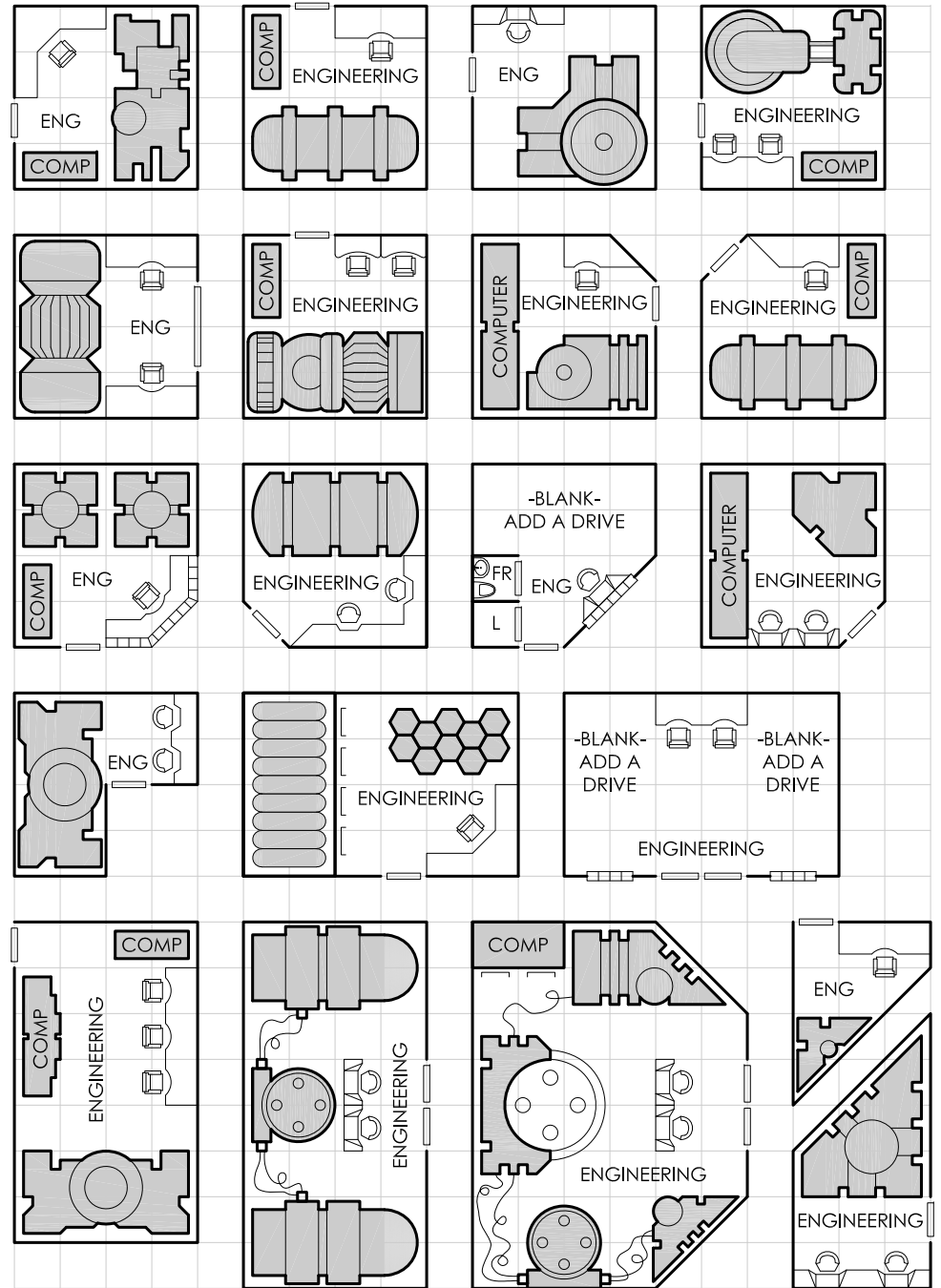
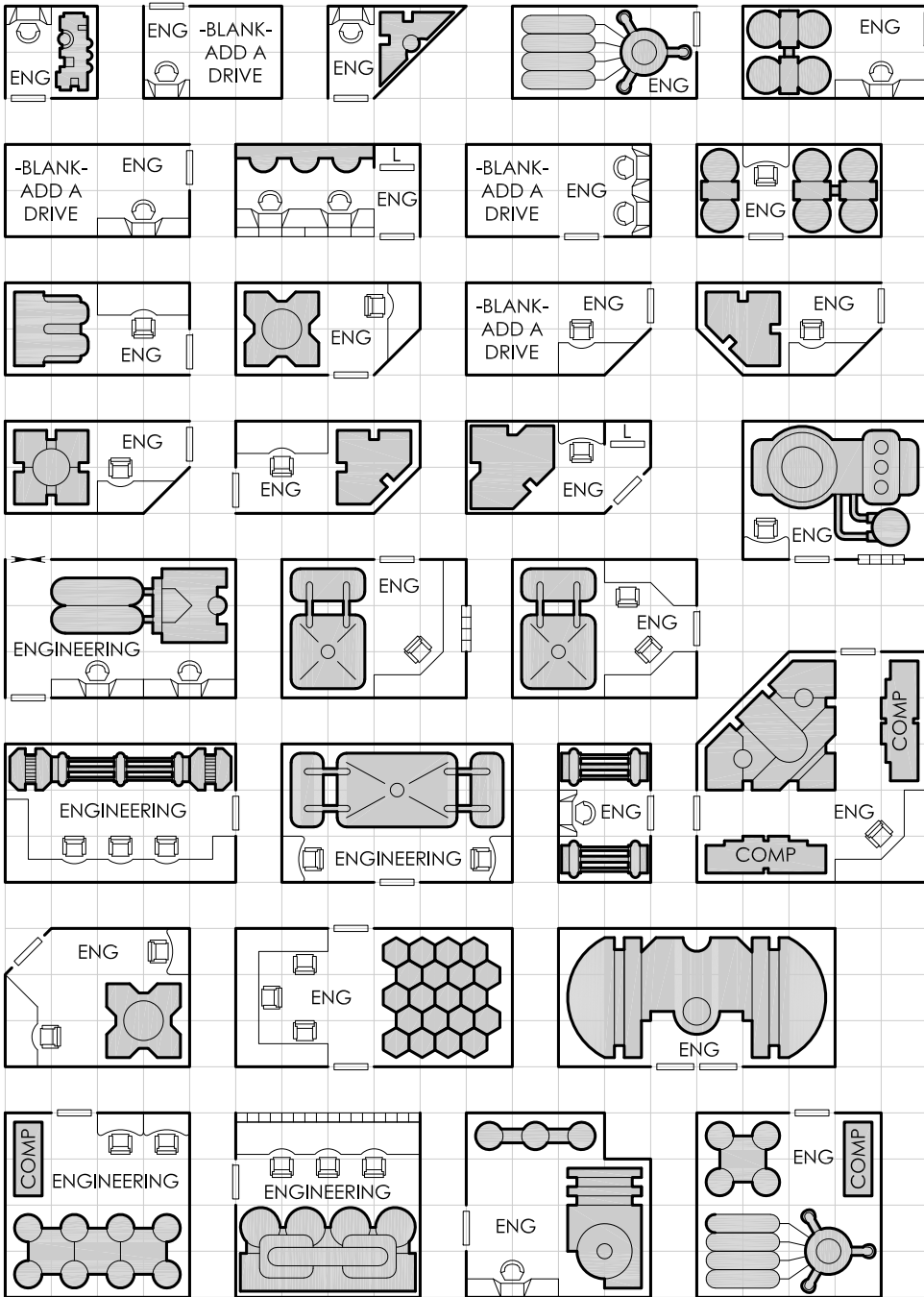

Engineering - Ship's Drive Room

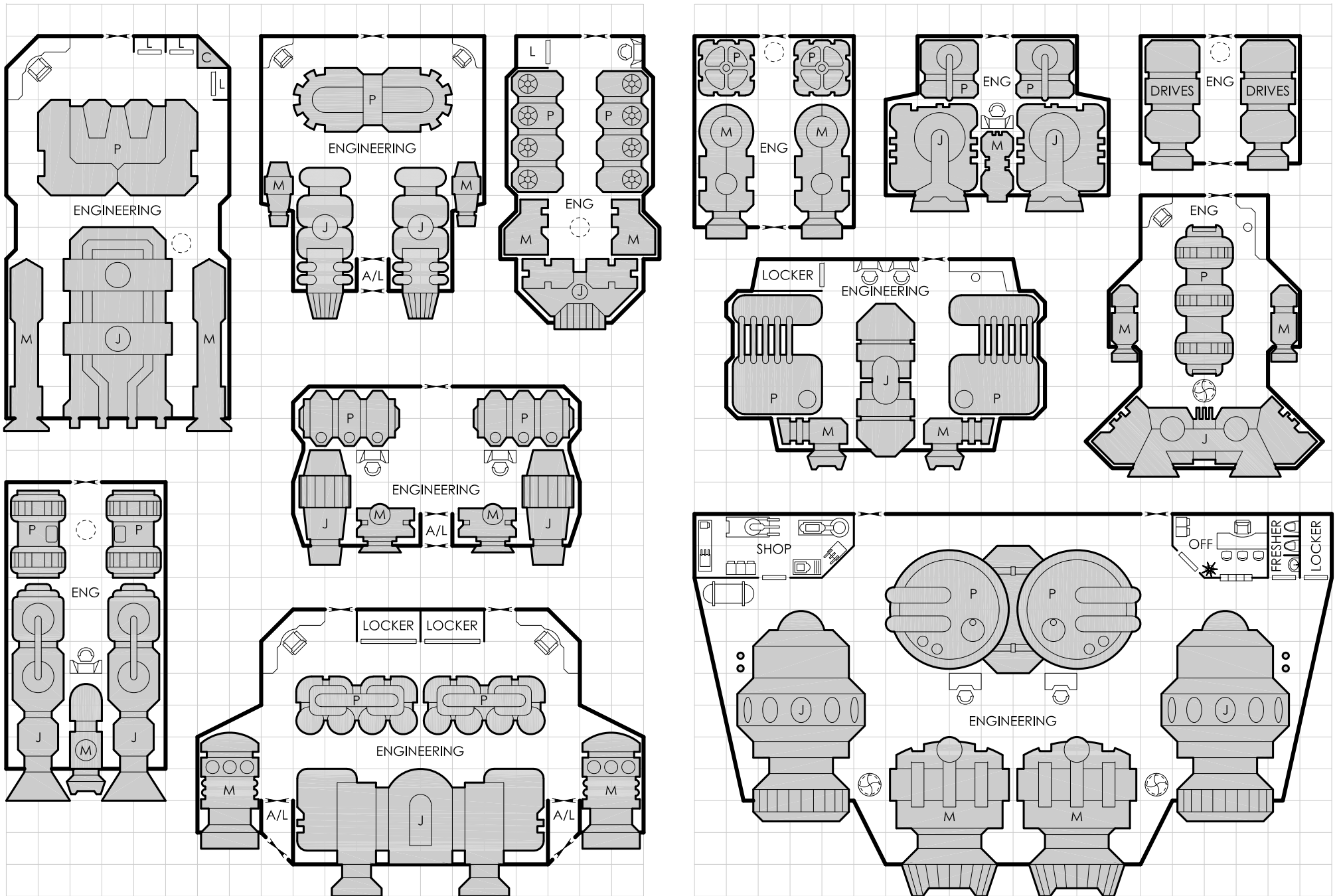

Engineering

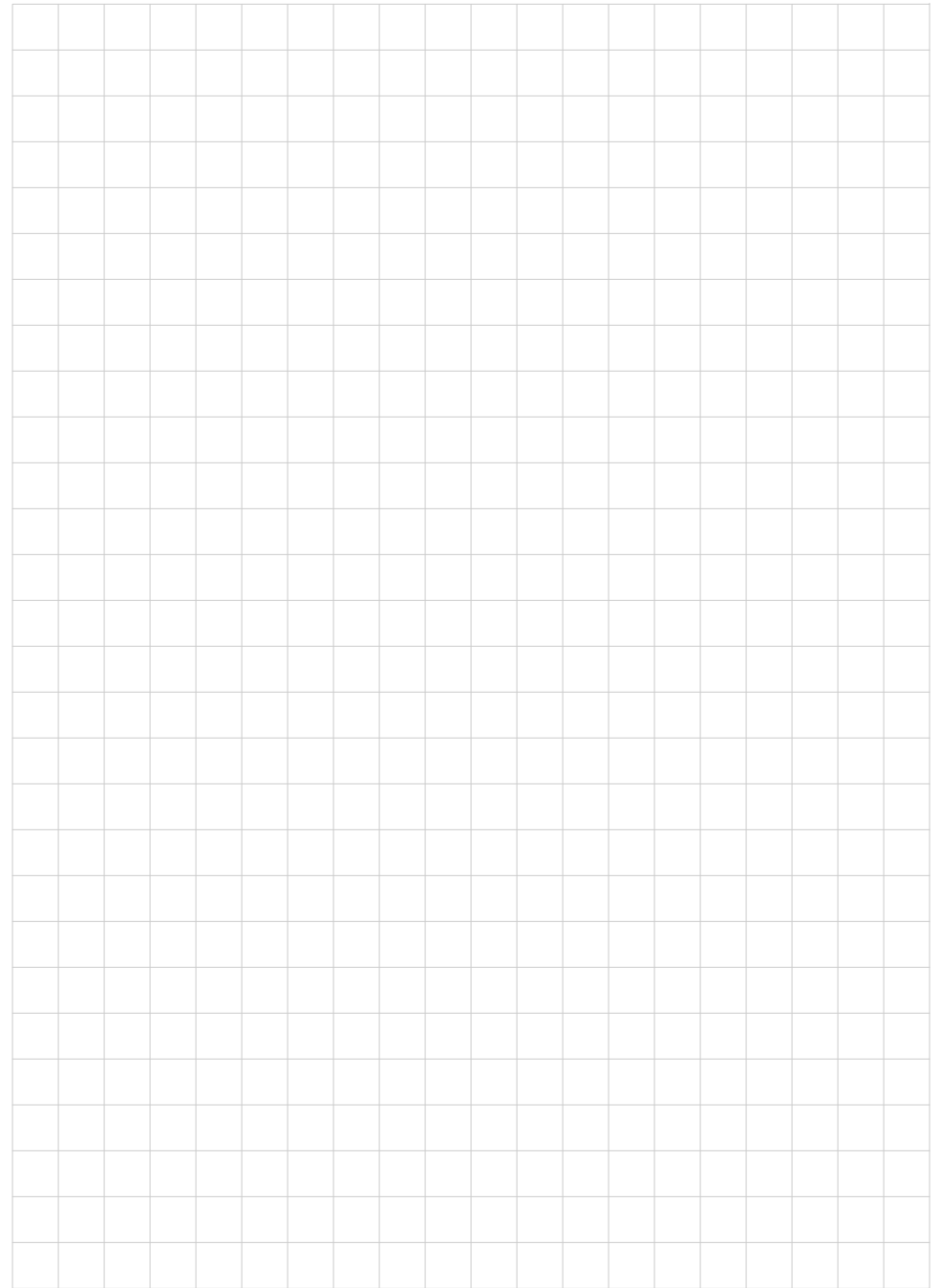
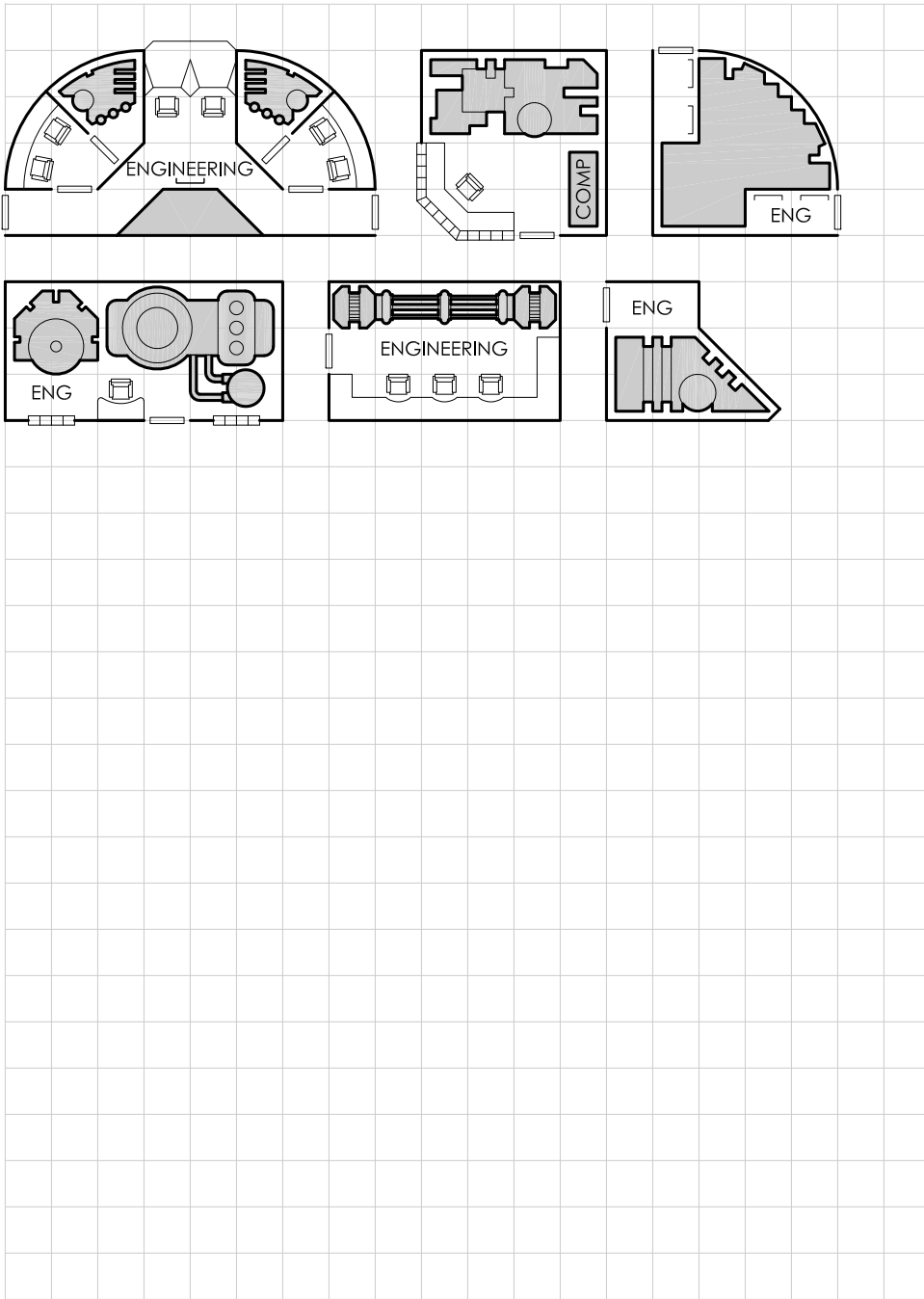

Fuel Tankage and Related Equipment

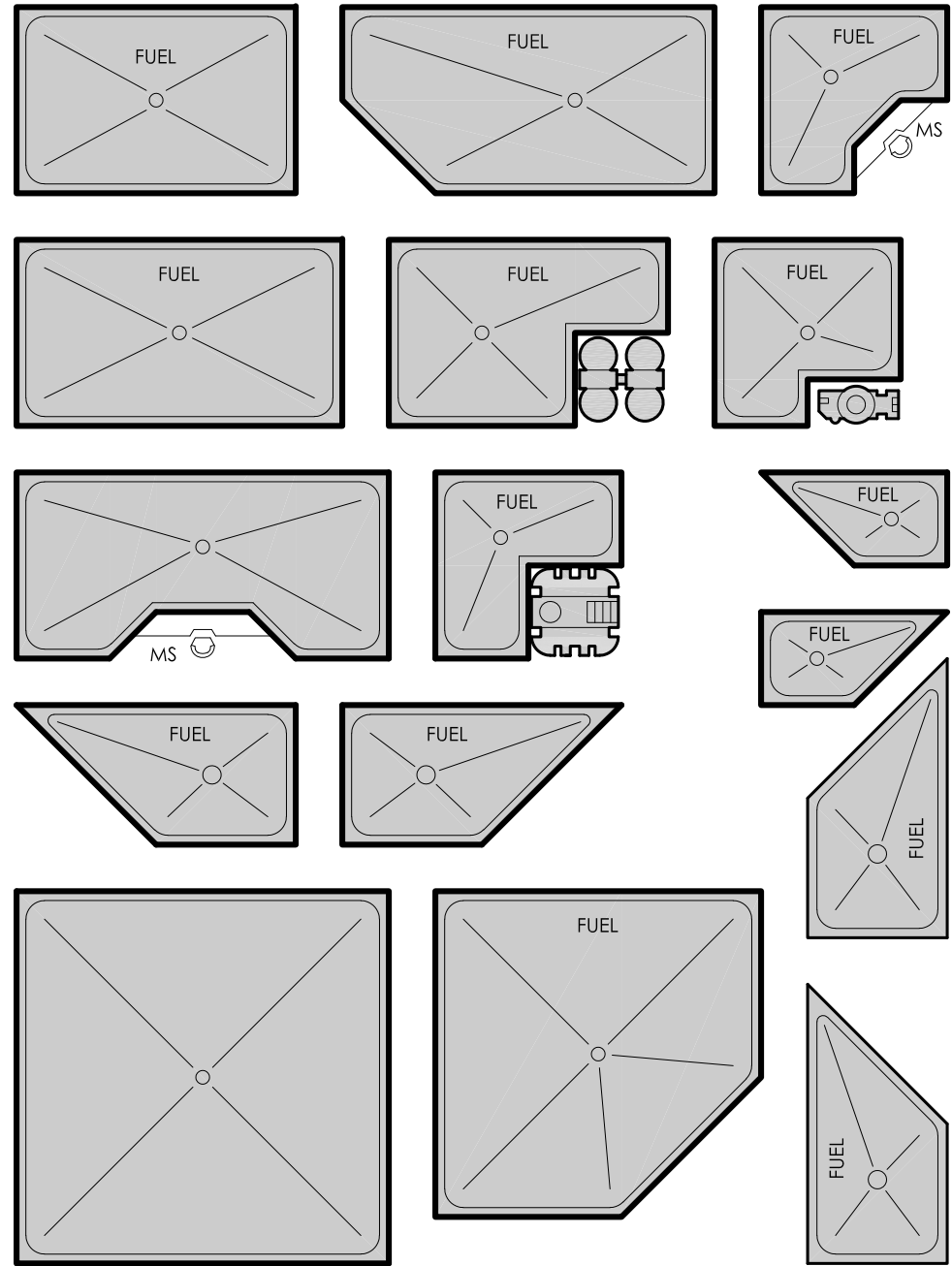
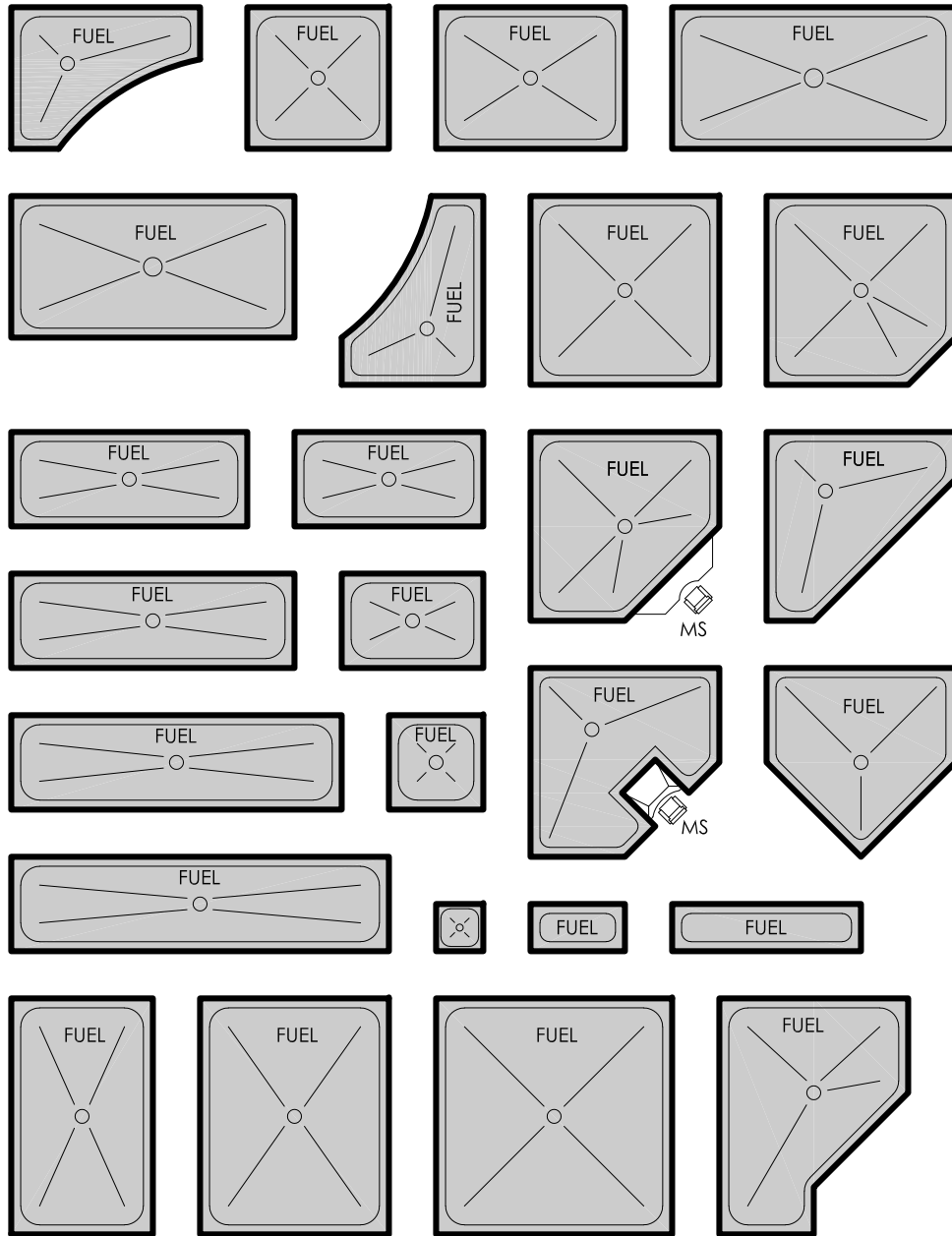

Fuel Tankage and Related Equipment

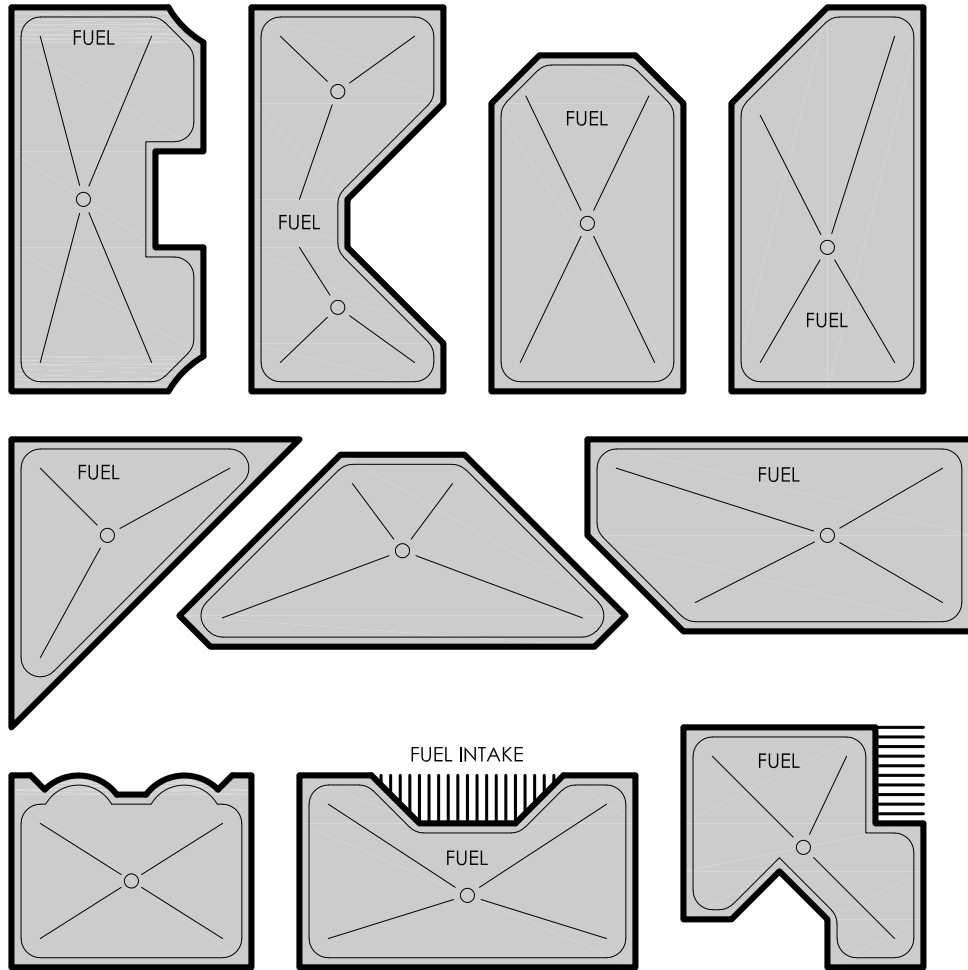

FUEL INTAKE SCOOPS



FUEL OPS

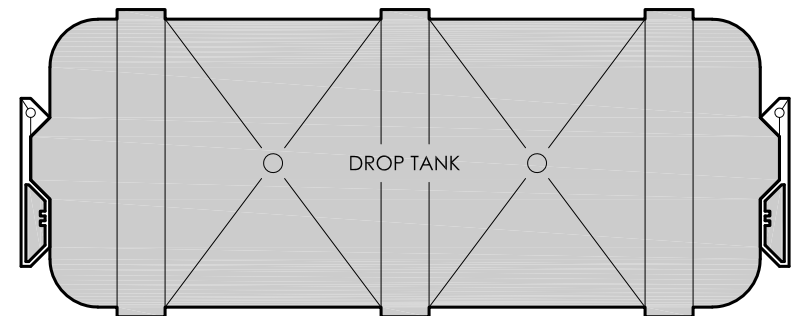
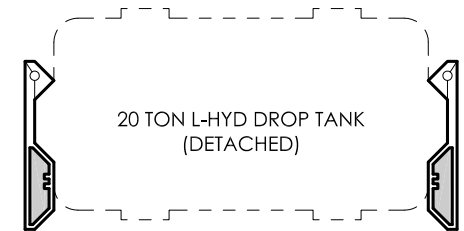
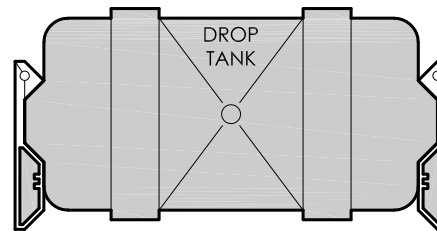
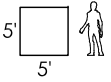
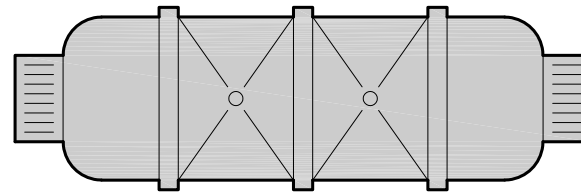
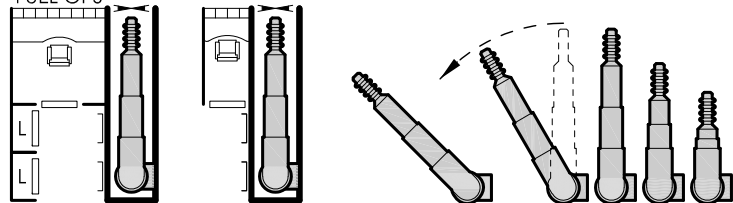

Freshers

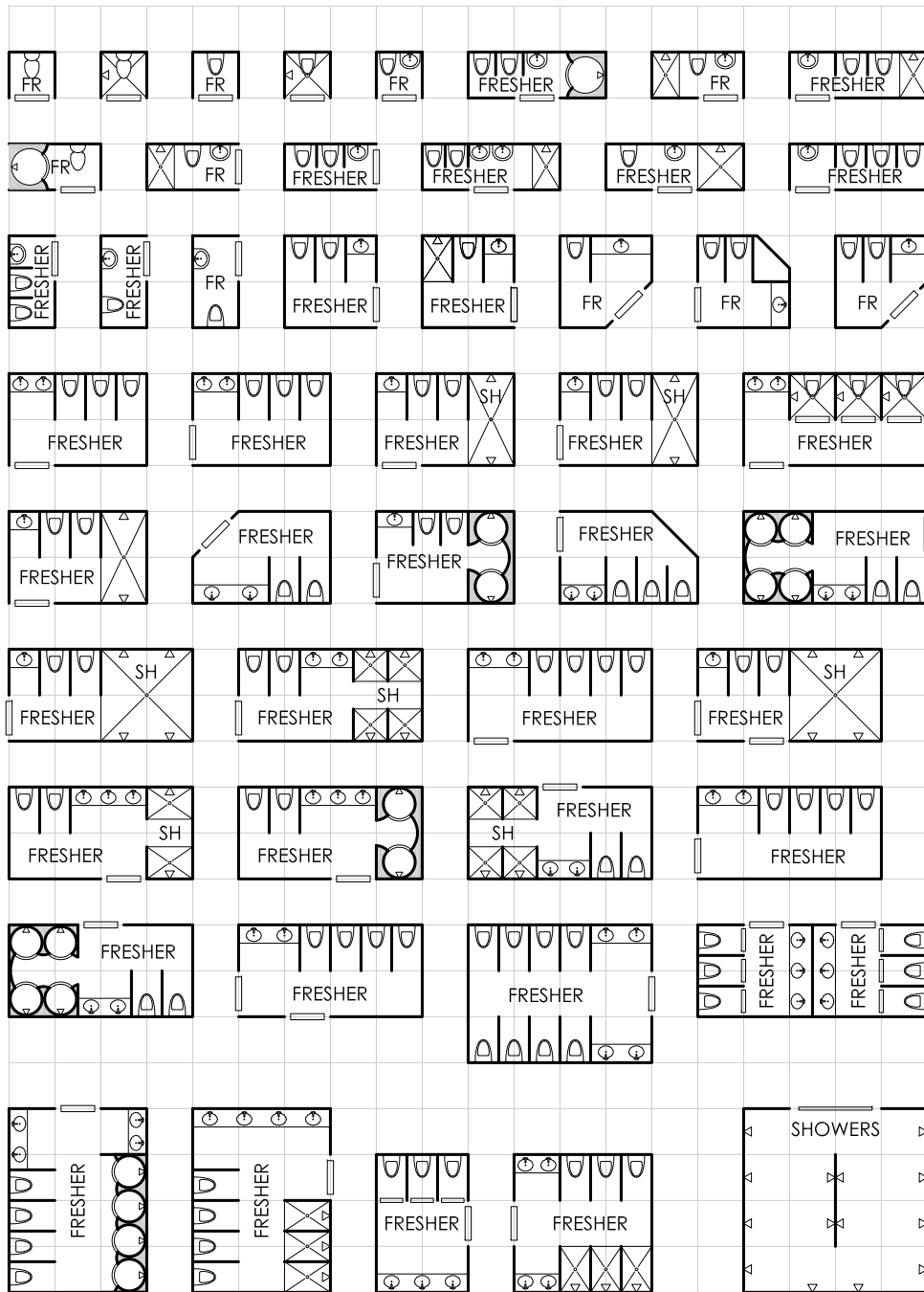

Utility Spaces

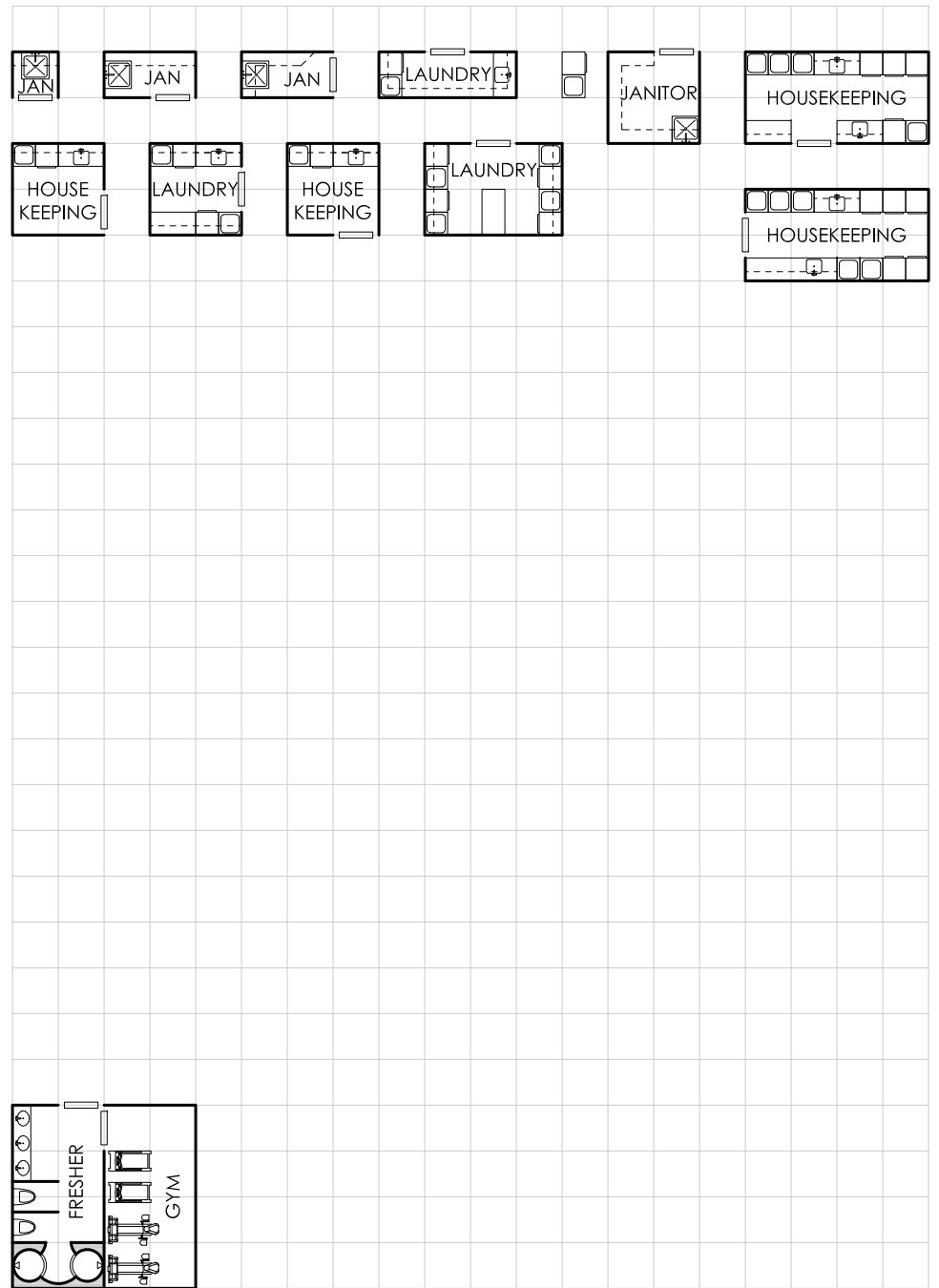

Galleys, Mess Halls, and Related Spaces

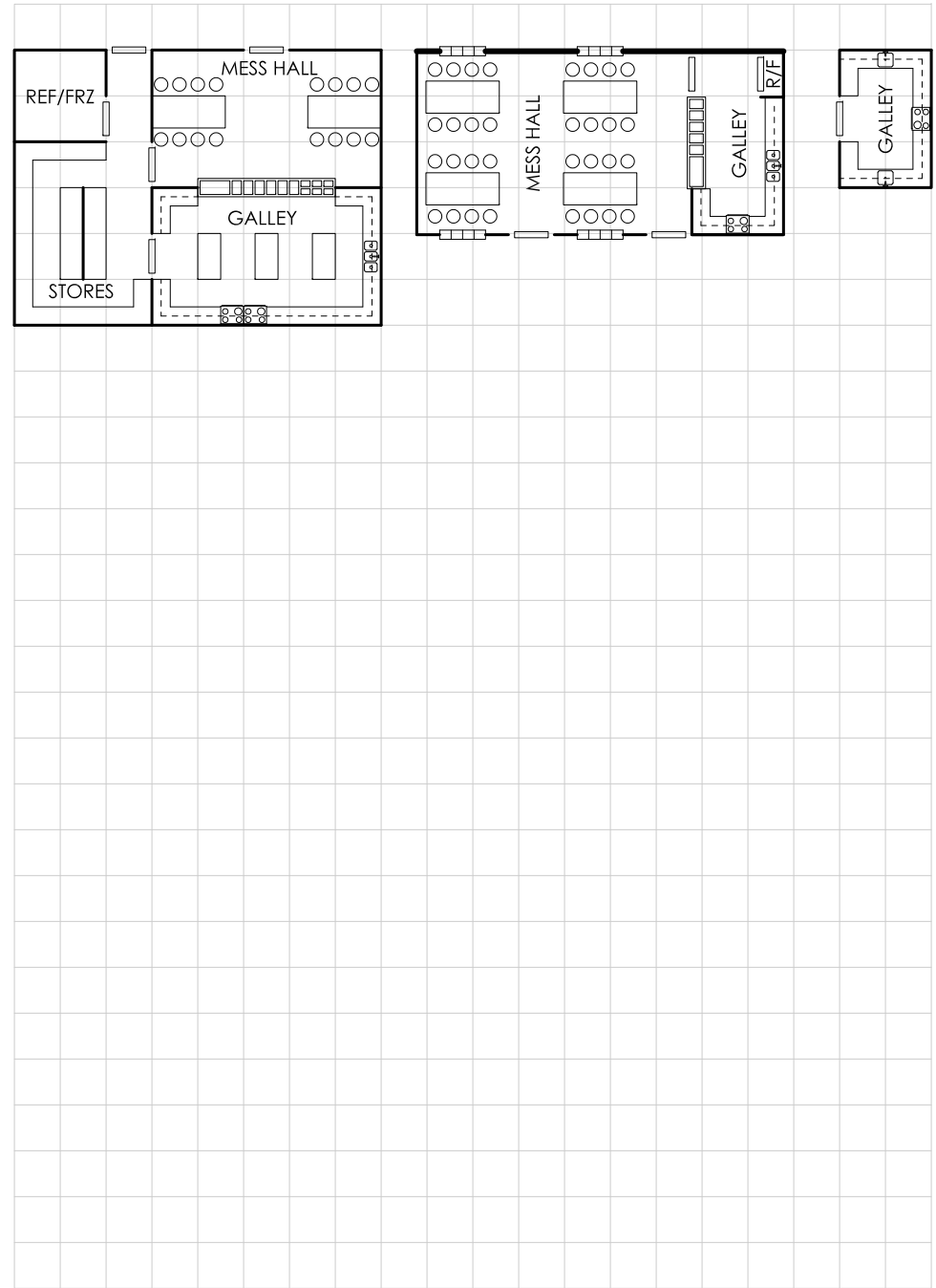
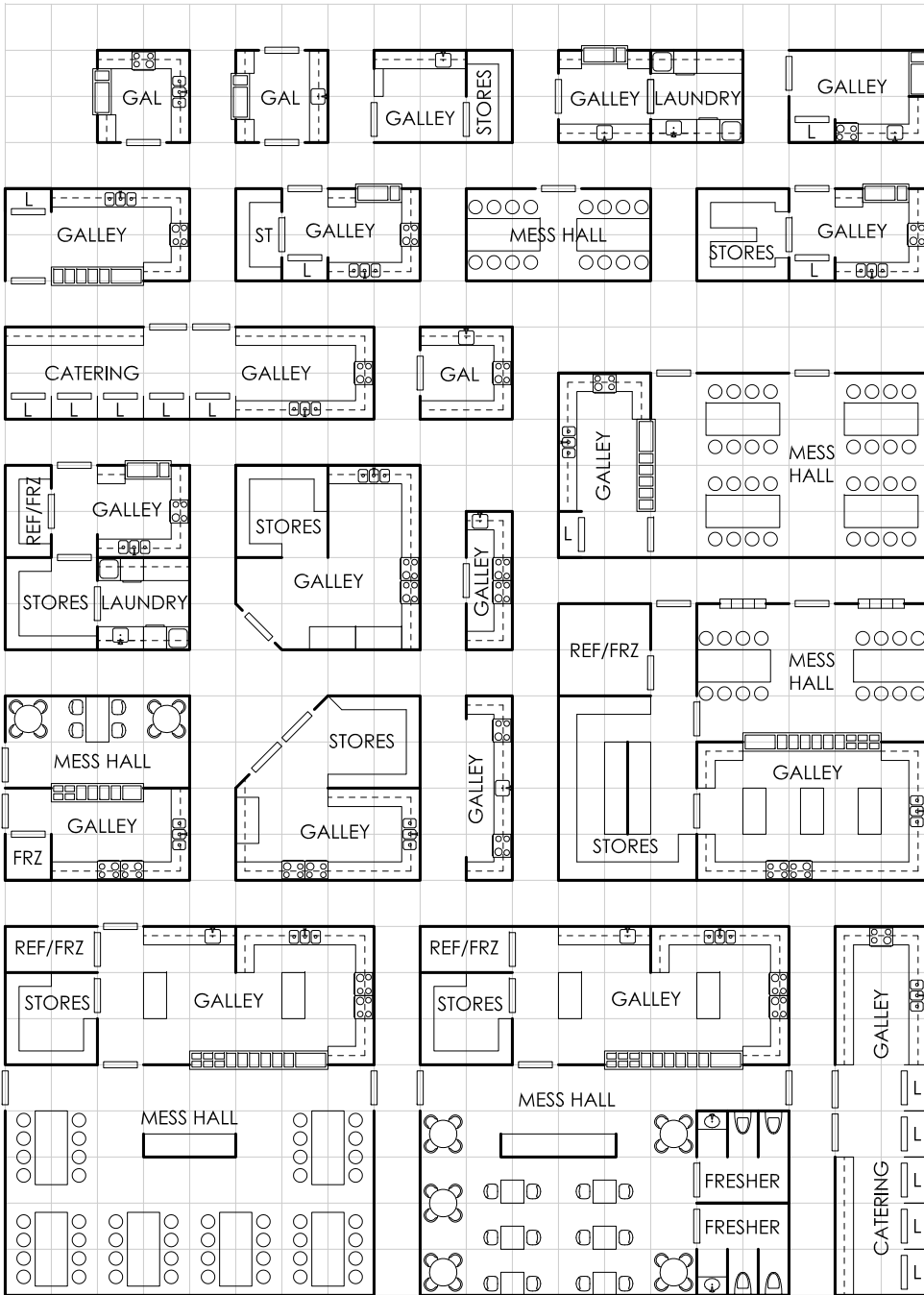

Lounges, Common Areas, and Bars

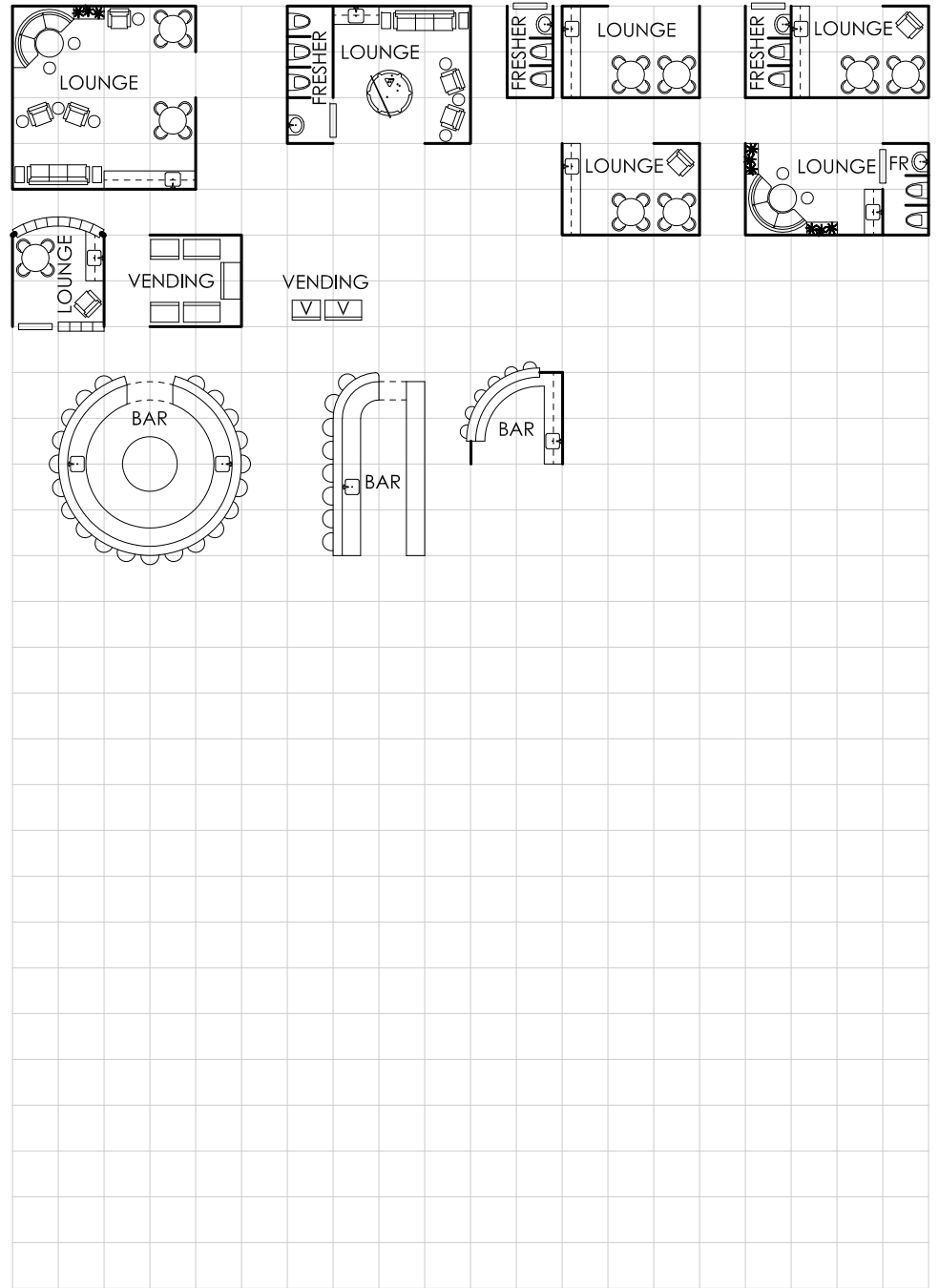
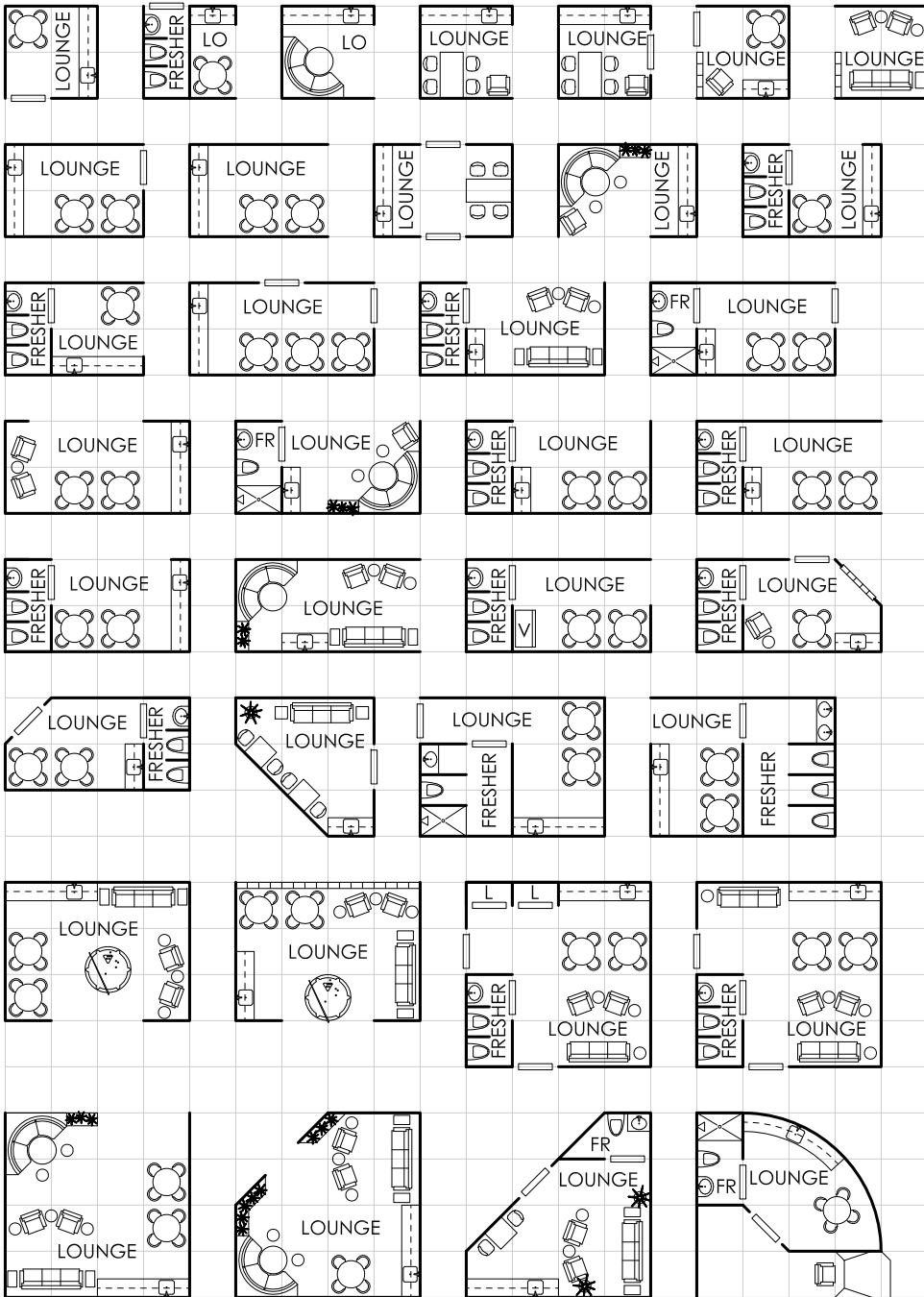

Briefing & Meeting Rooms, Classrooms

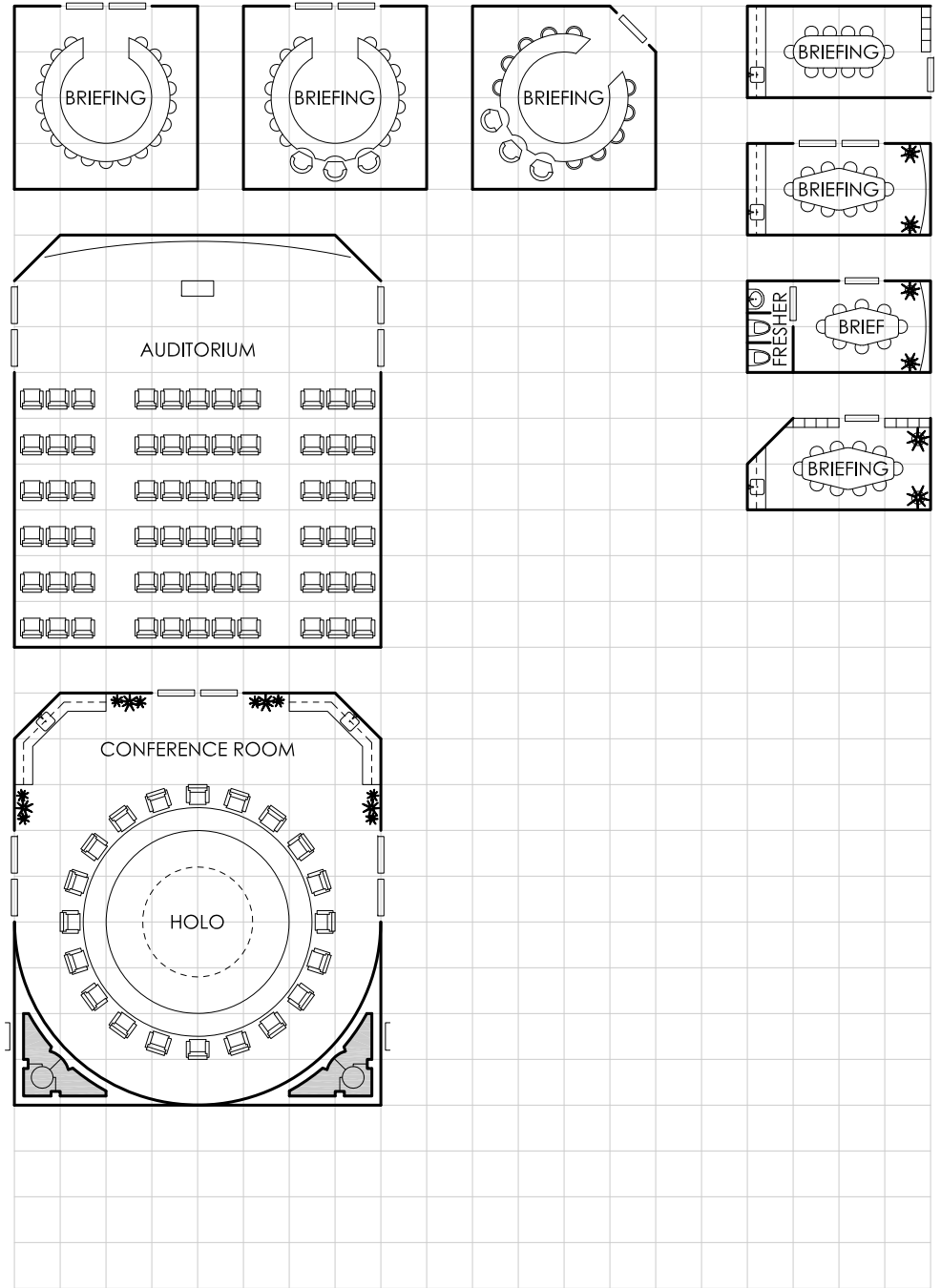
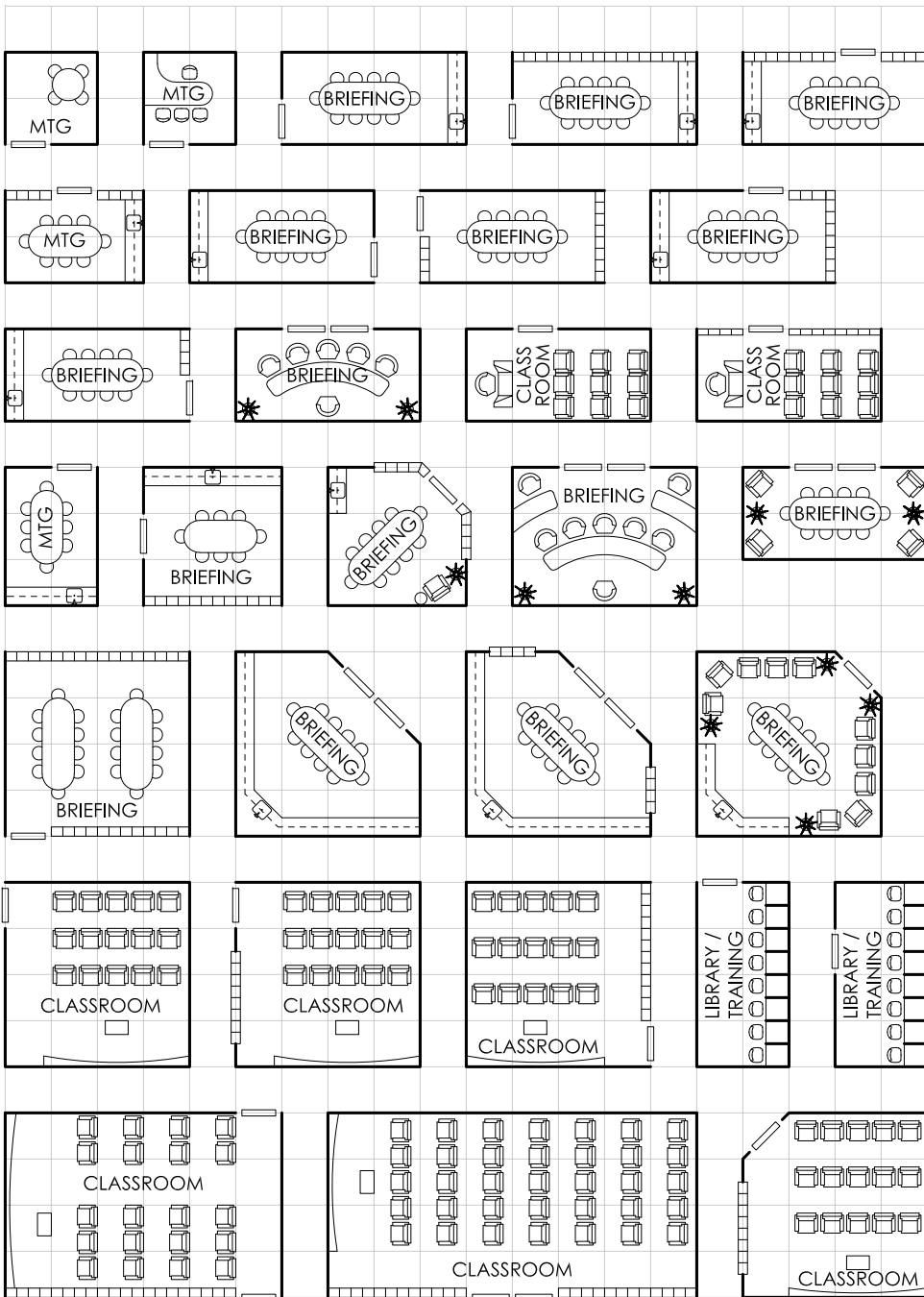

Small Hangars , Flight Control Rooms, Workpods

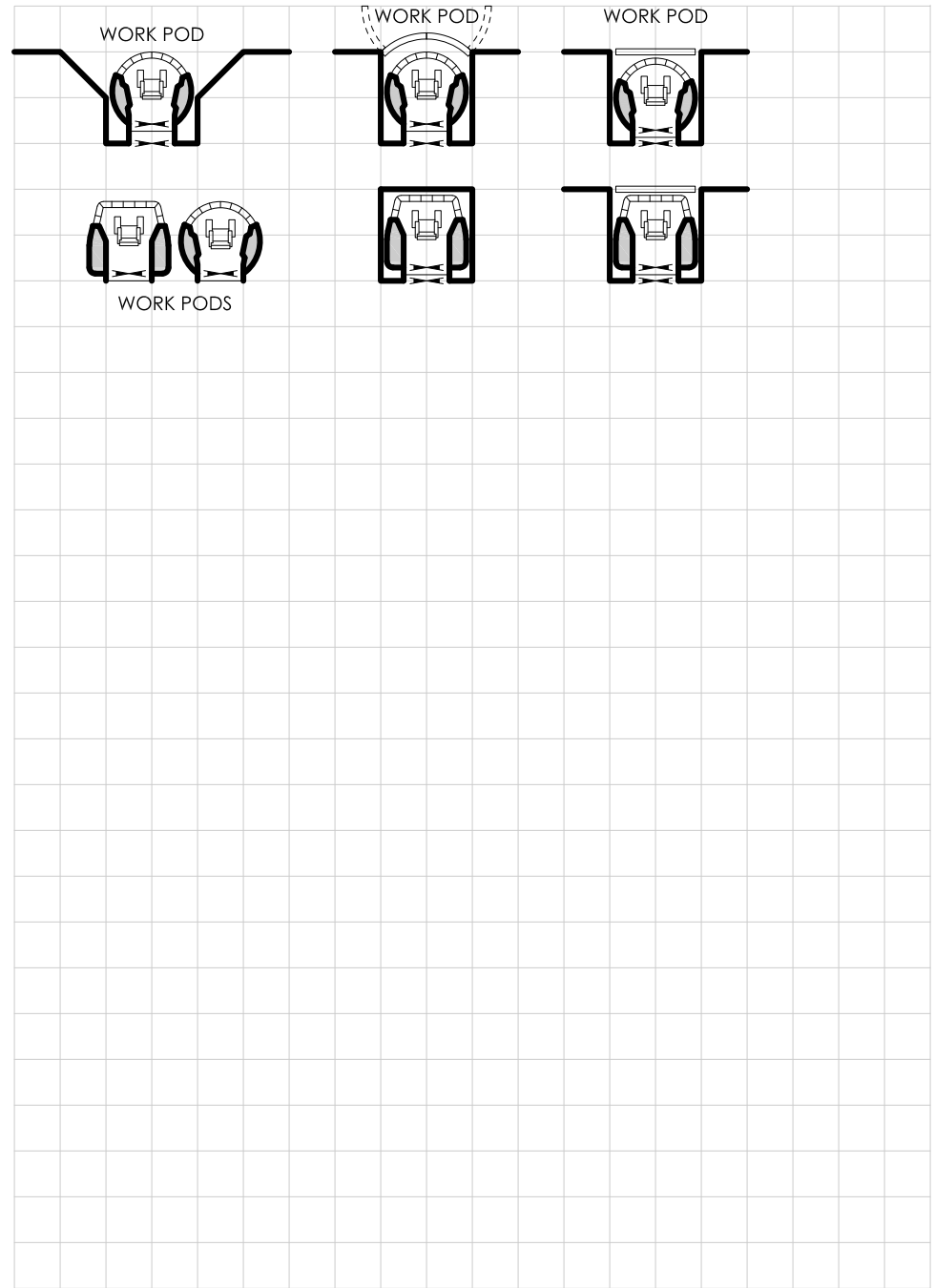
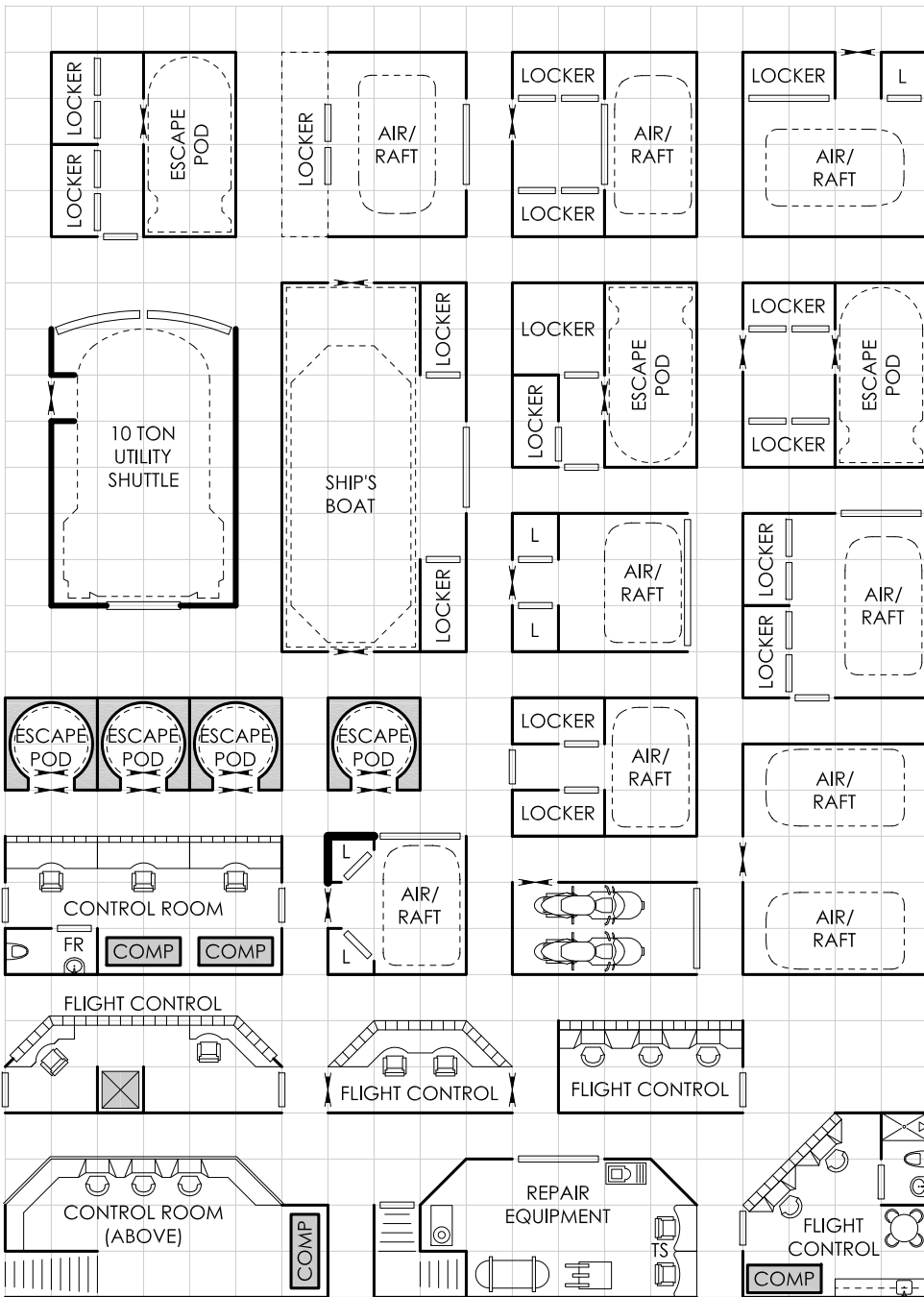

Laboratories

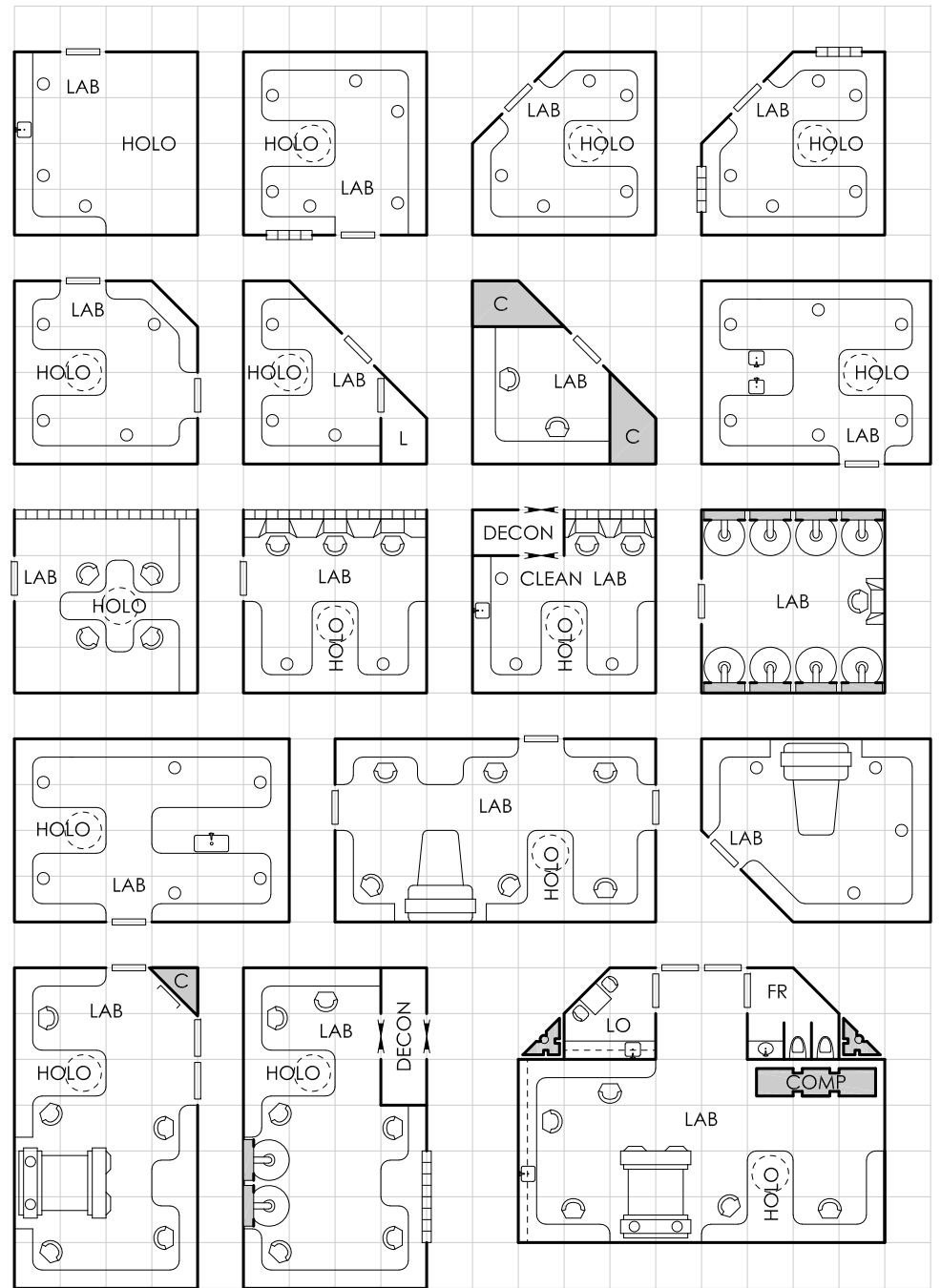
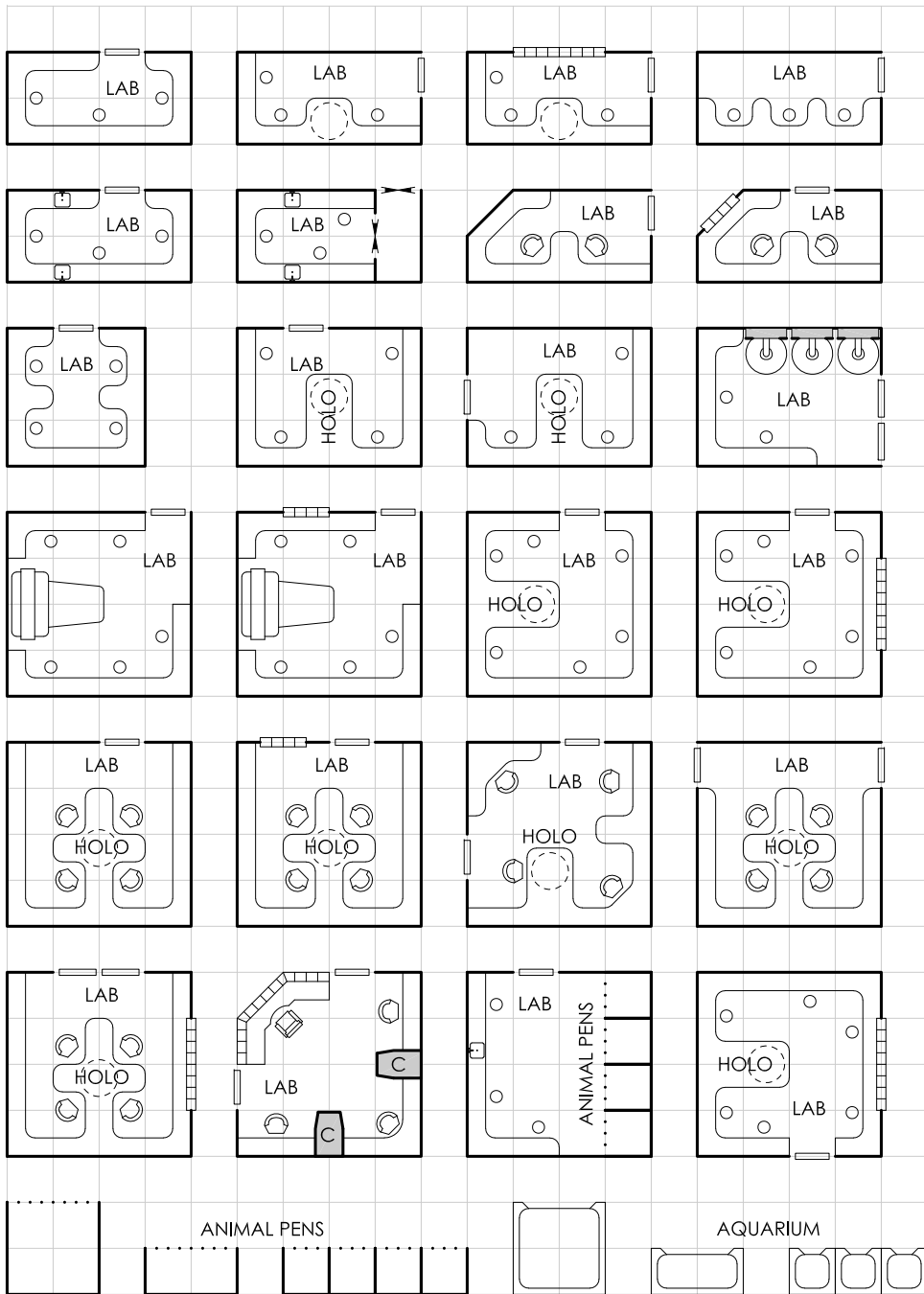

Laboratories

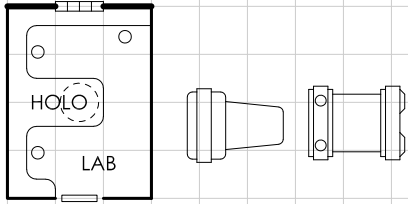

Ship's Lockers, Storage, and Retail Space

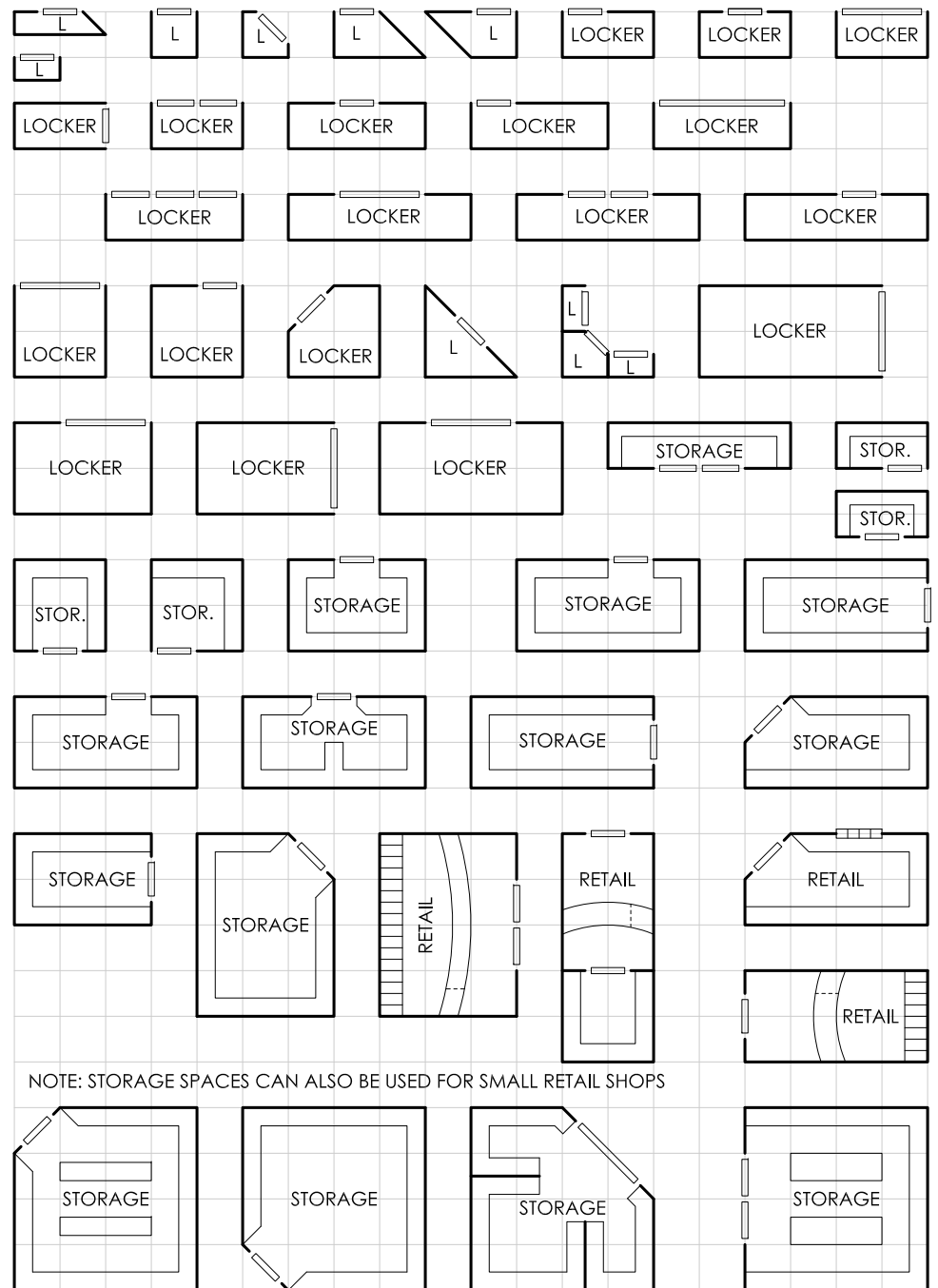

Medical (Sick Bays) and Low Berth Facilities

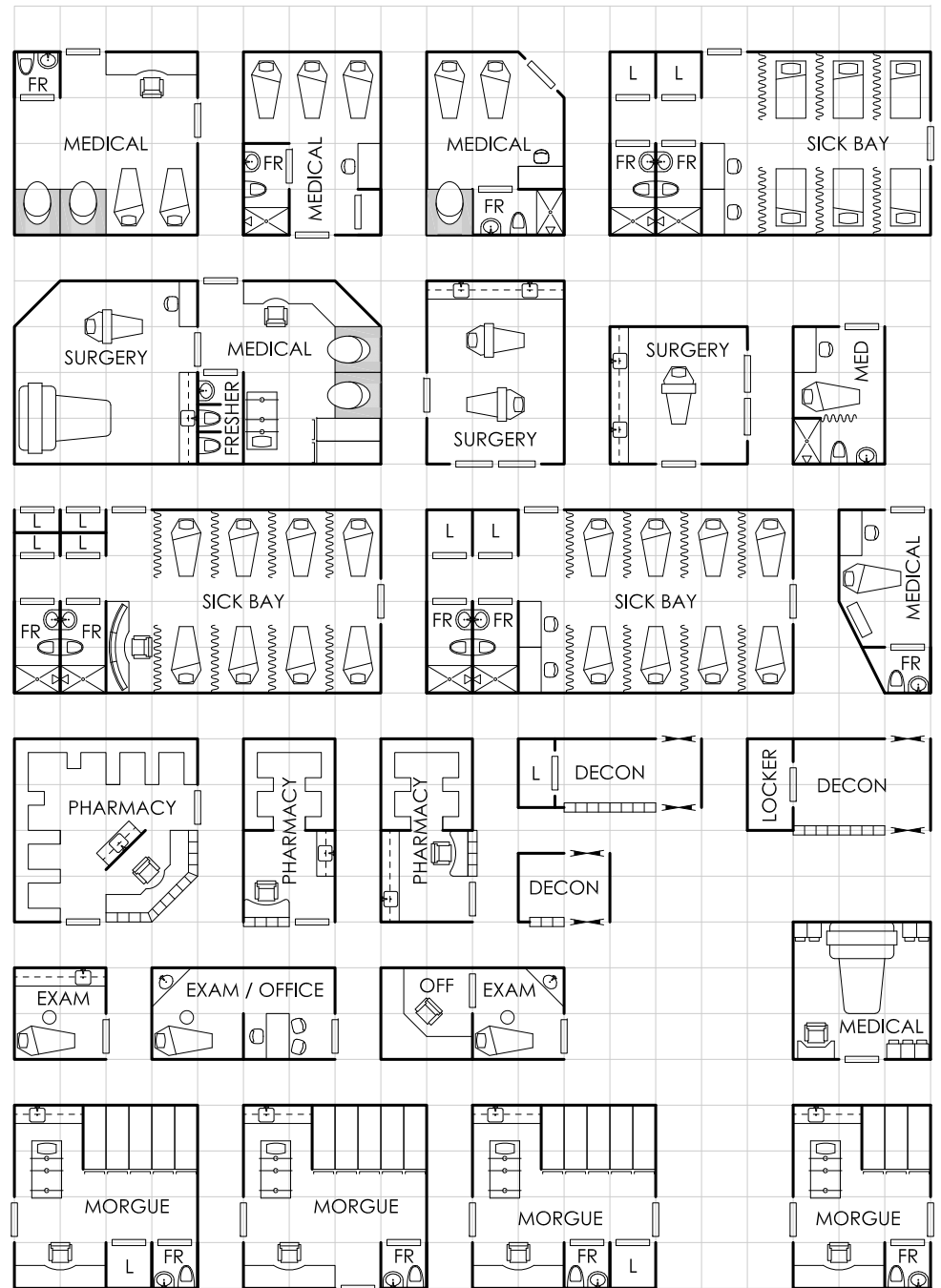
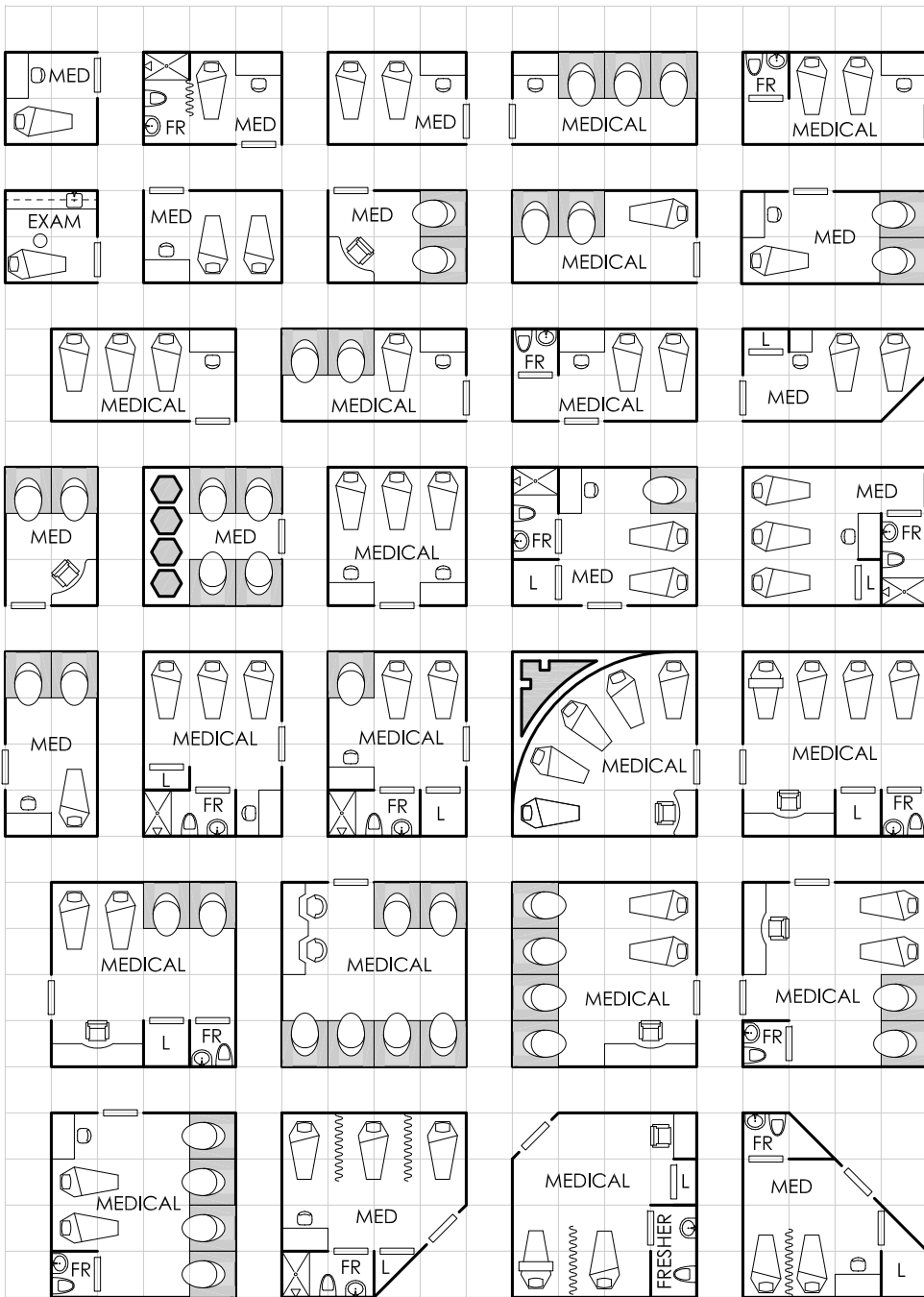

Medical (Sick Bays) and Low Berth Facilities

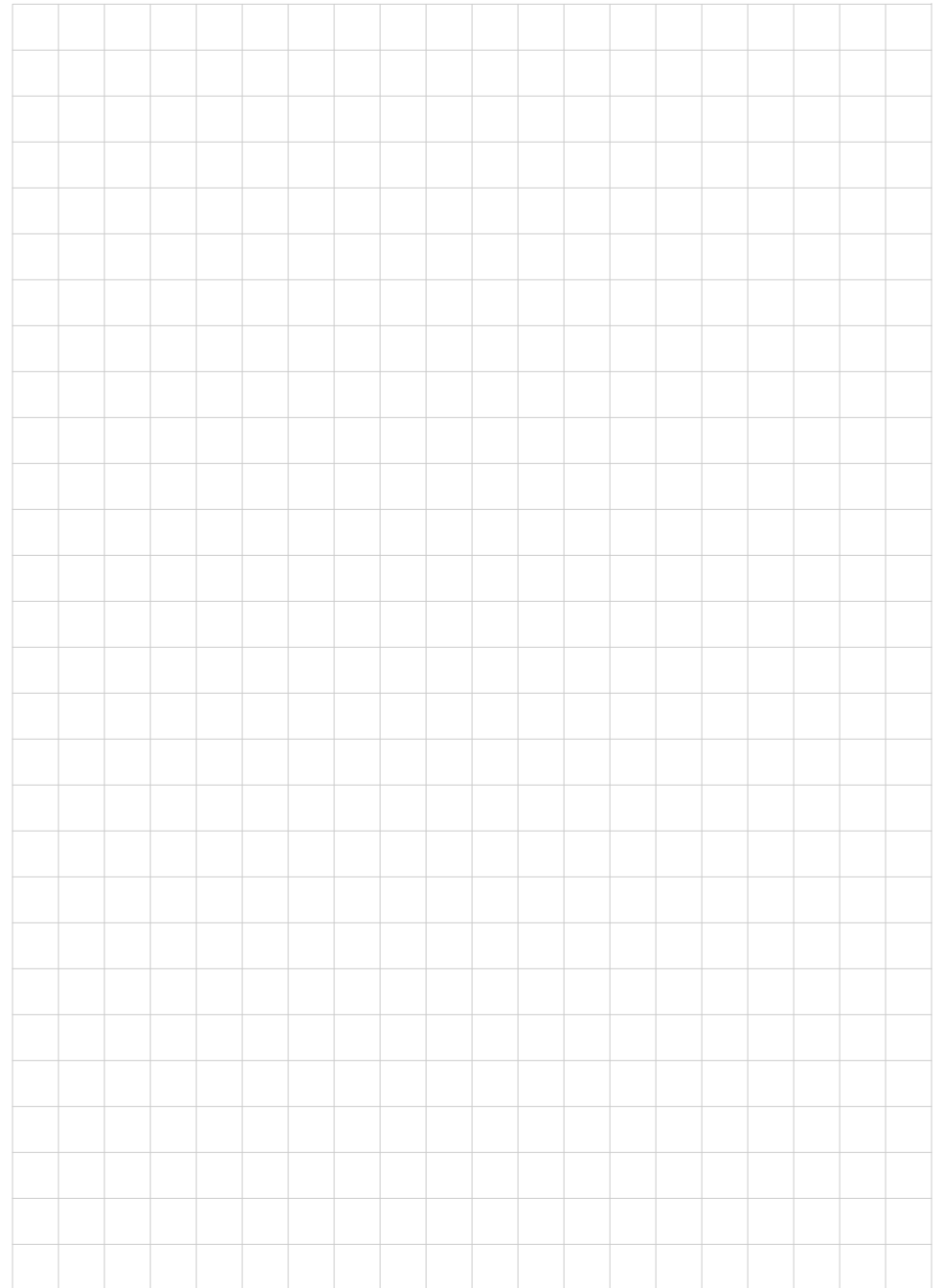
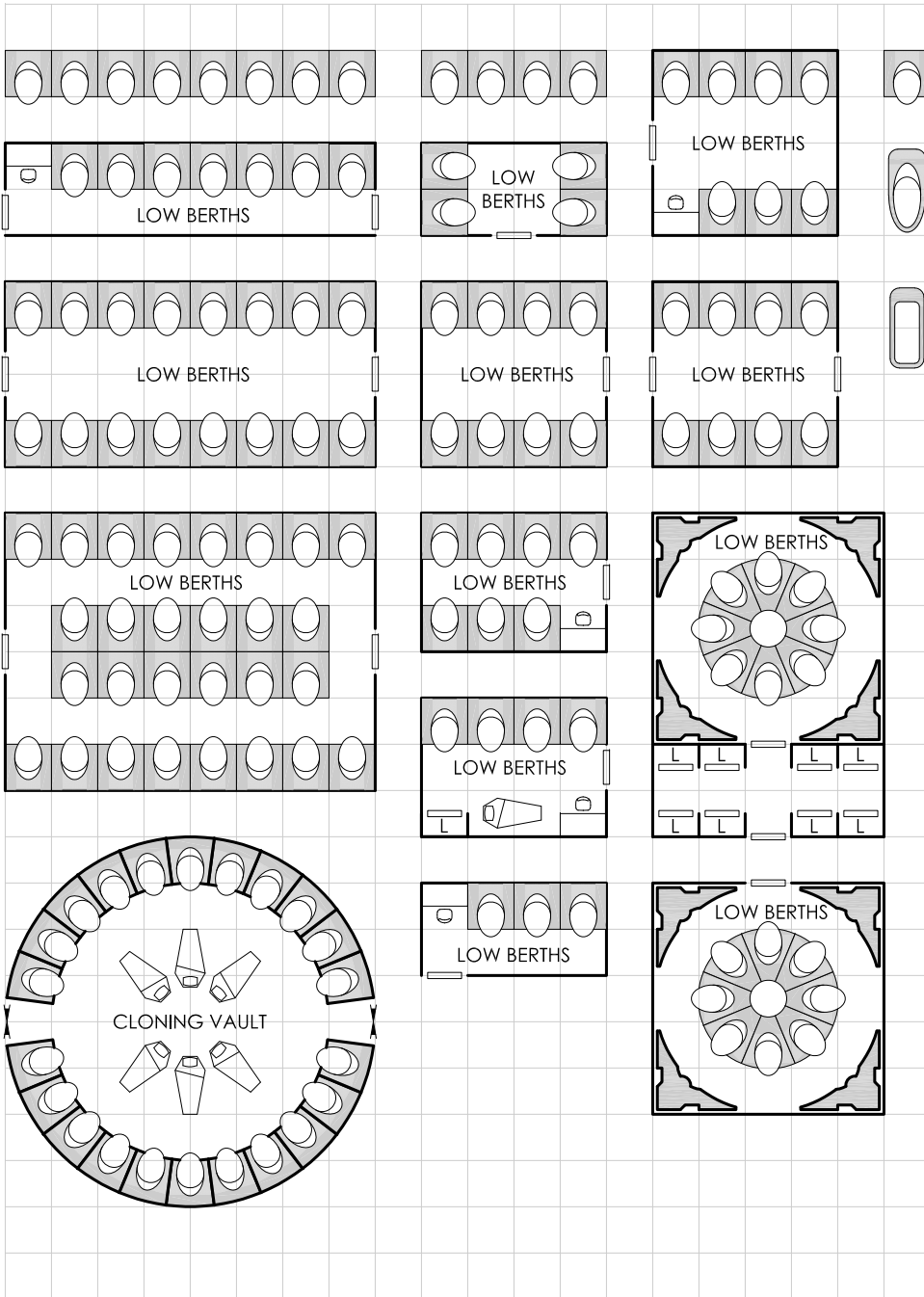

Offices (or Studios)

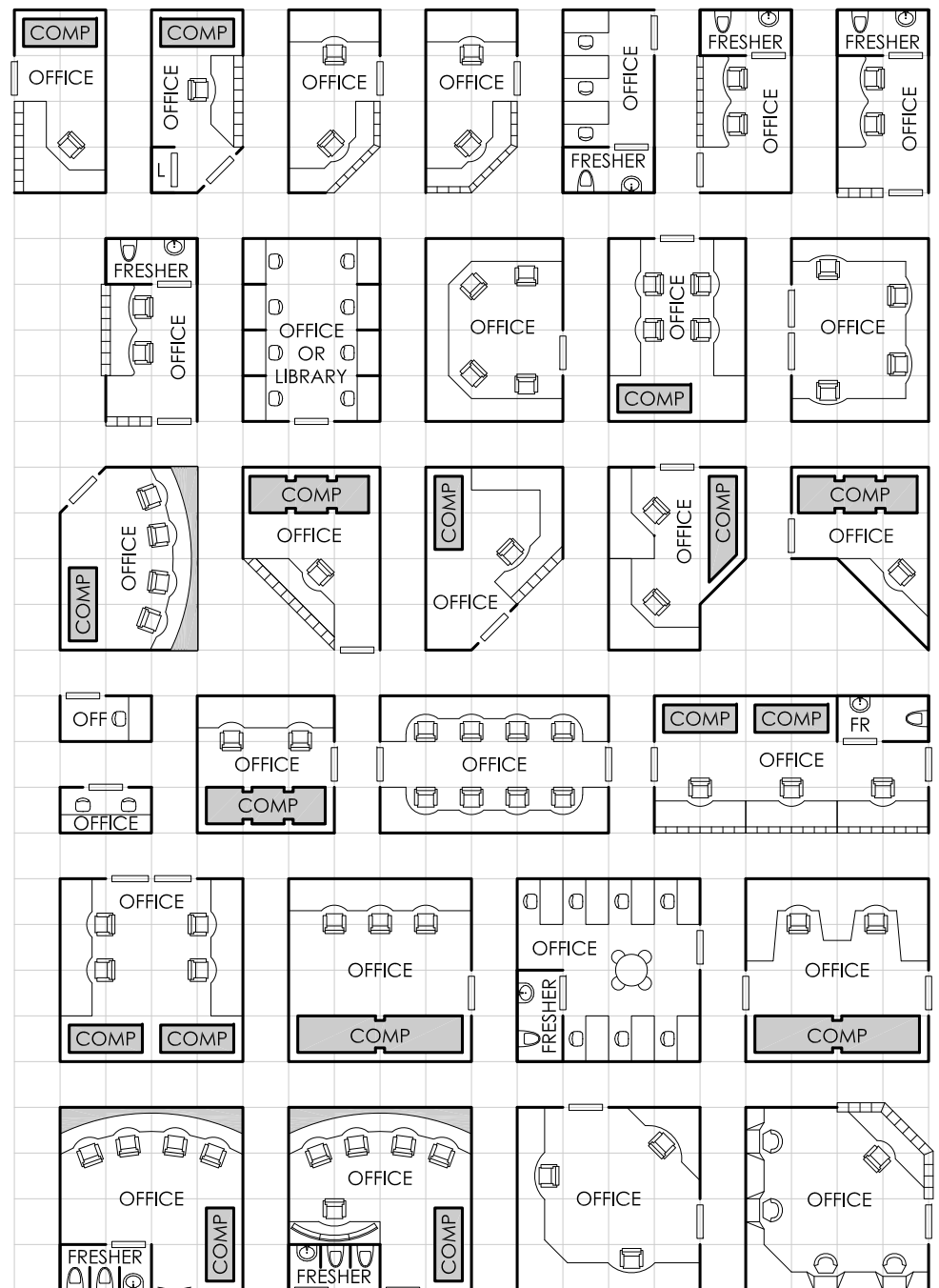
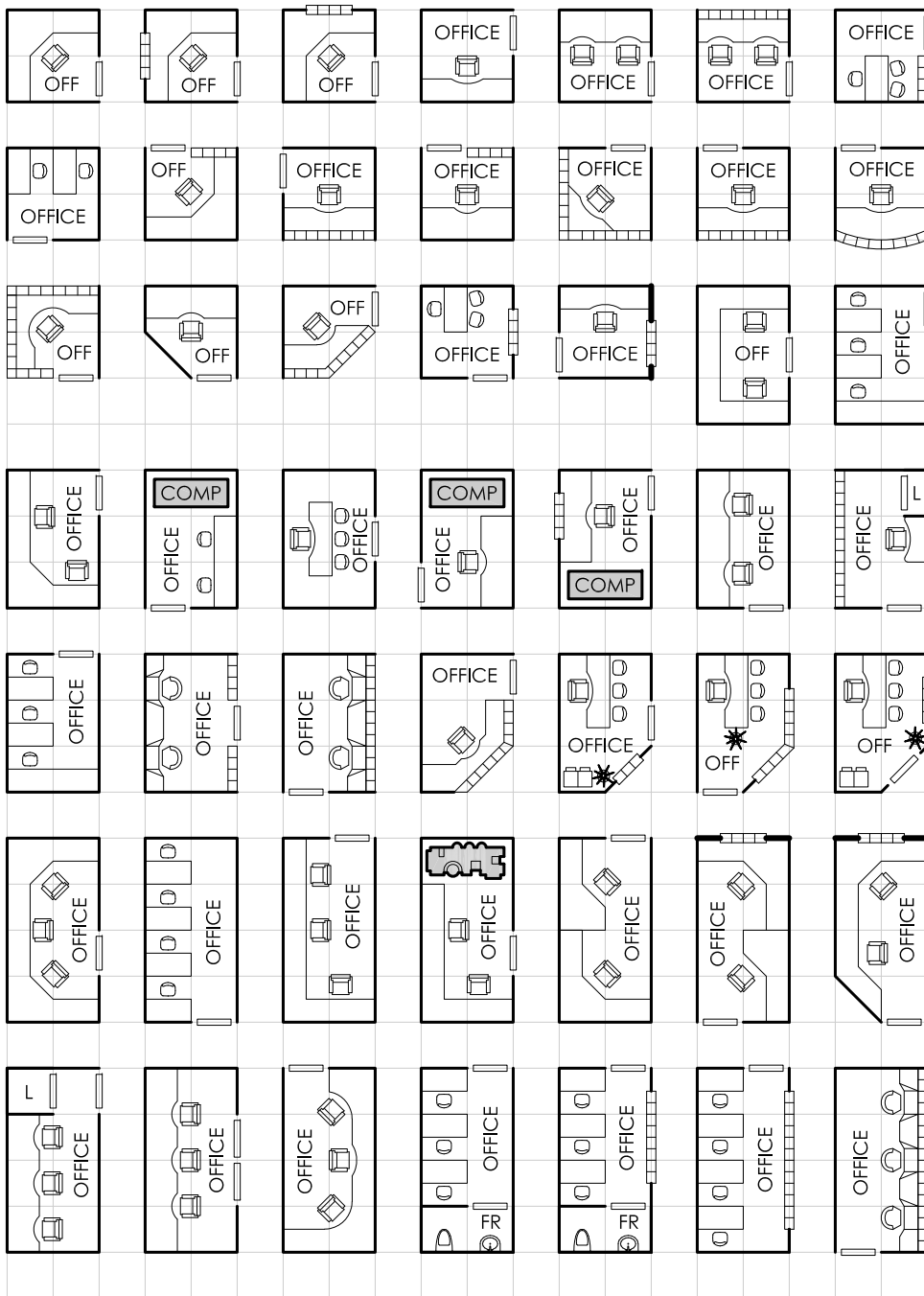

Offices (or Studios)

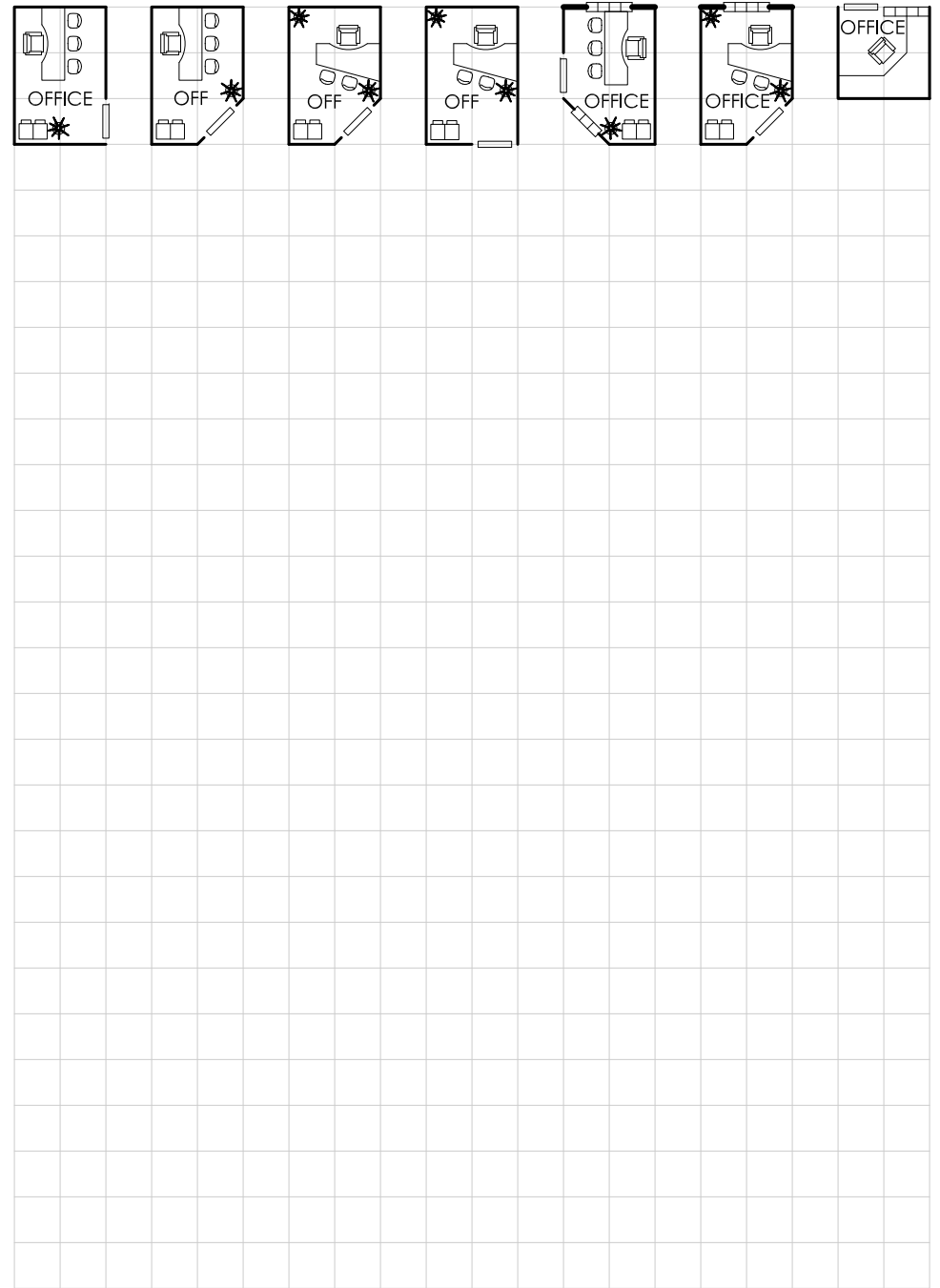
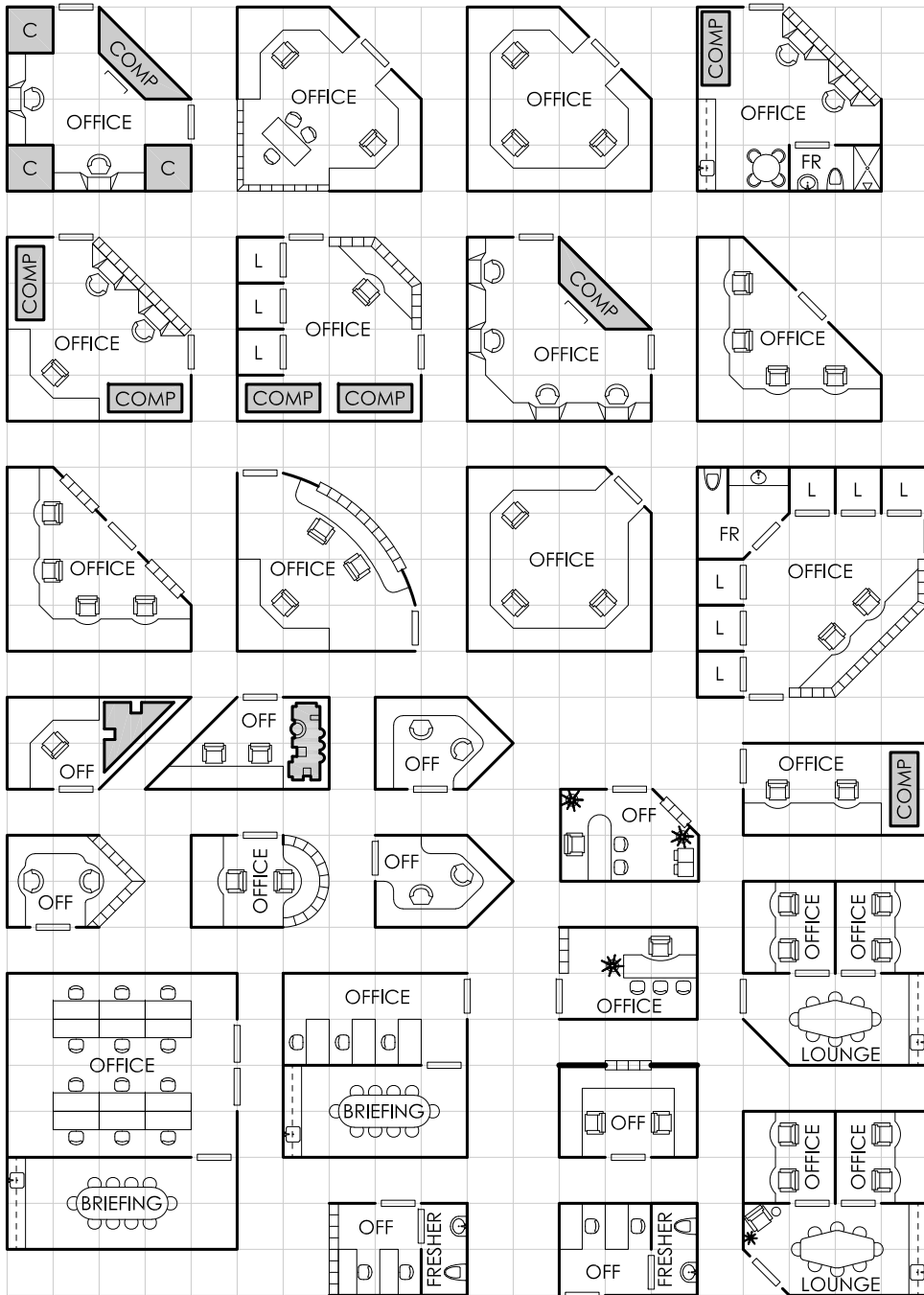

Shops and Repair Areas

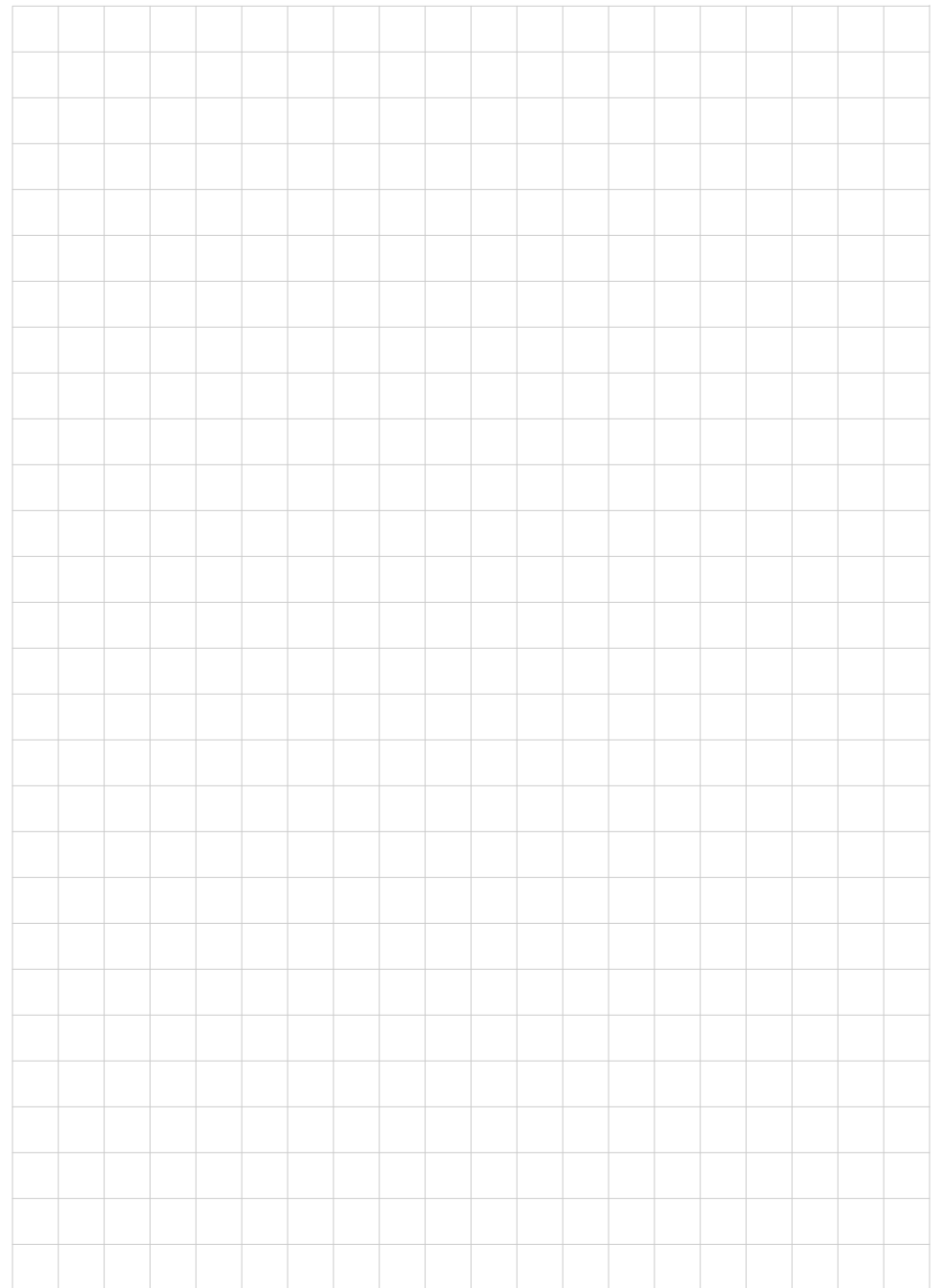

Security Offices

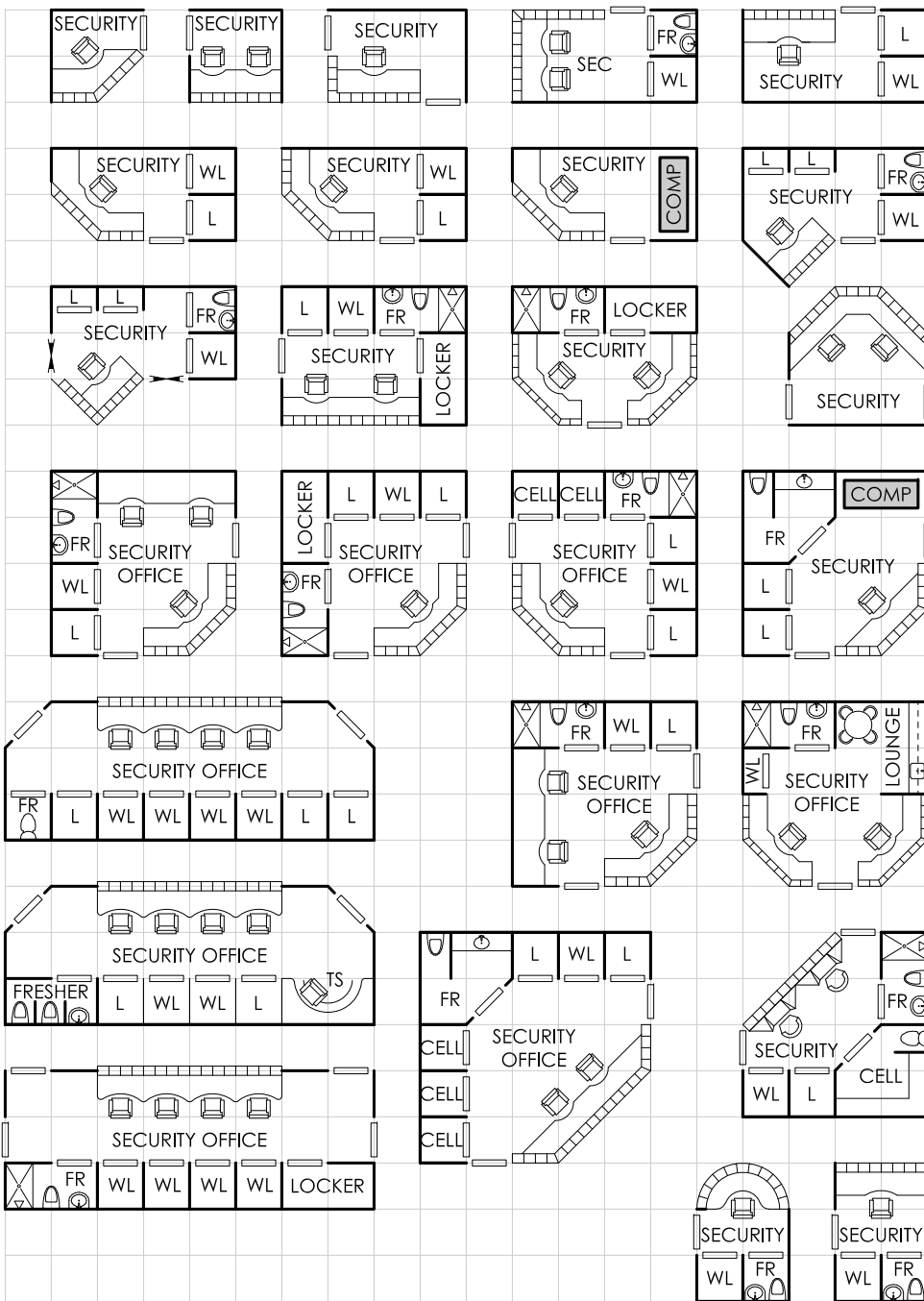

Brigs, Prisoner Cells, Cell Blocks

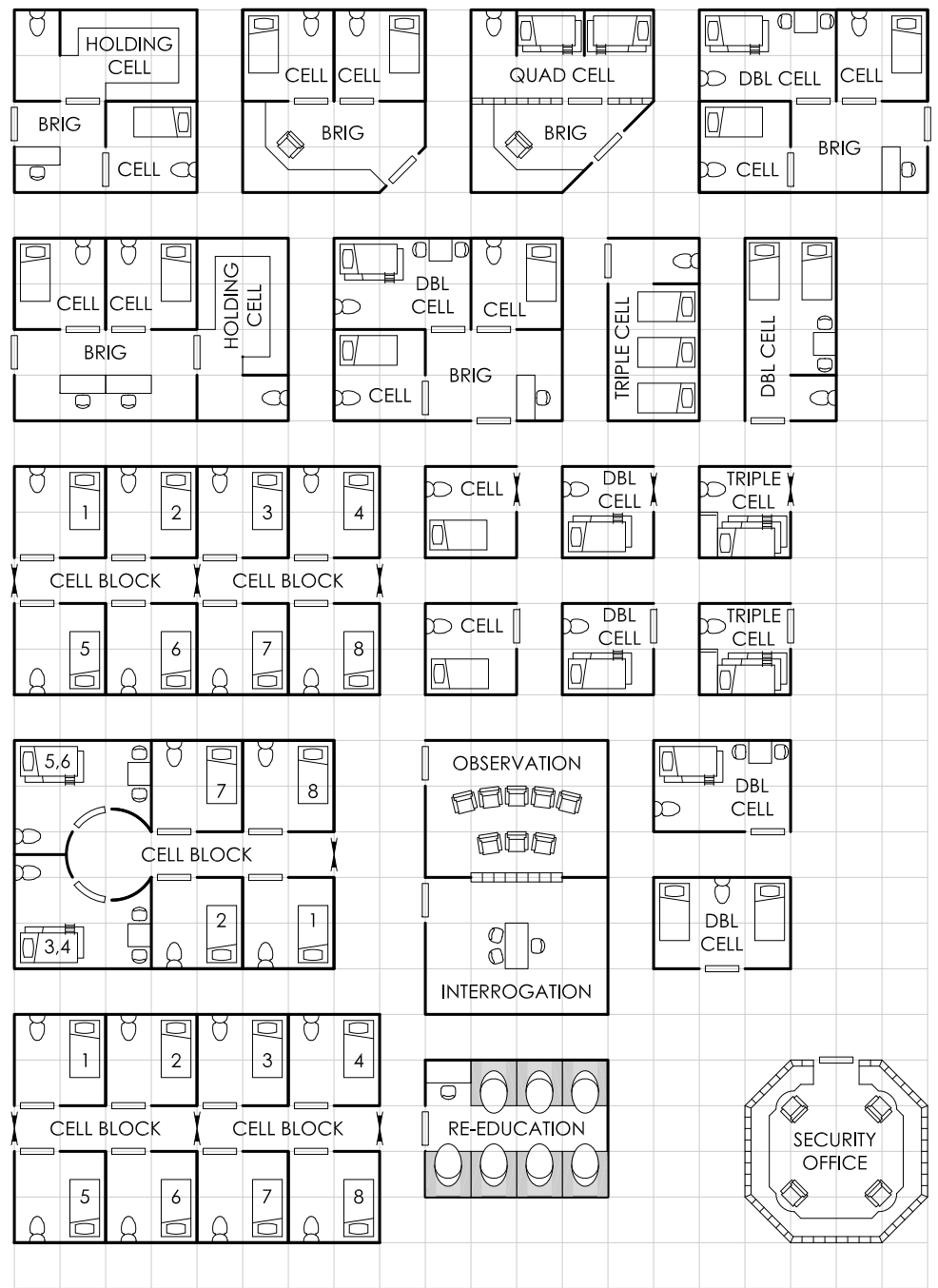

Staterooms and Related Spaces



Staterooms and Related Spaces



Staterooms and Steerage

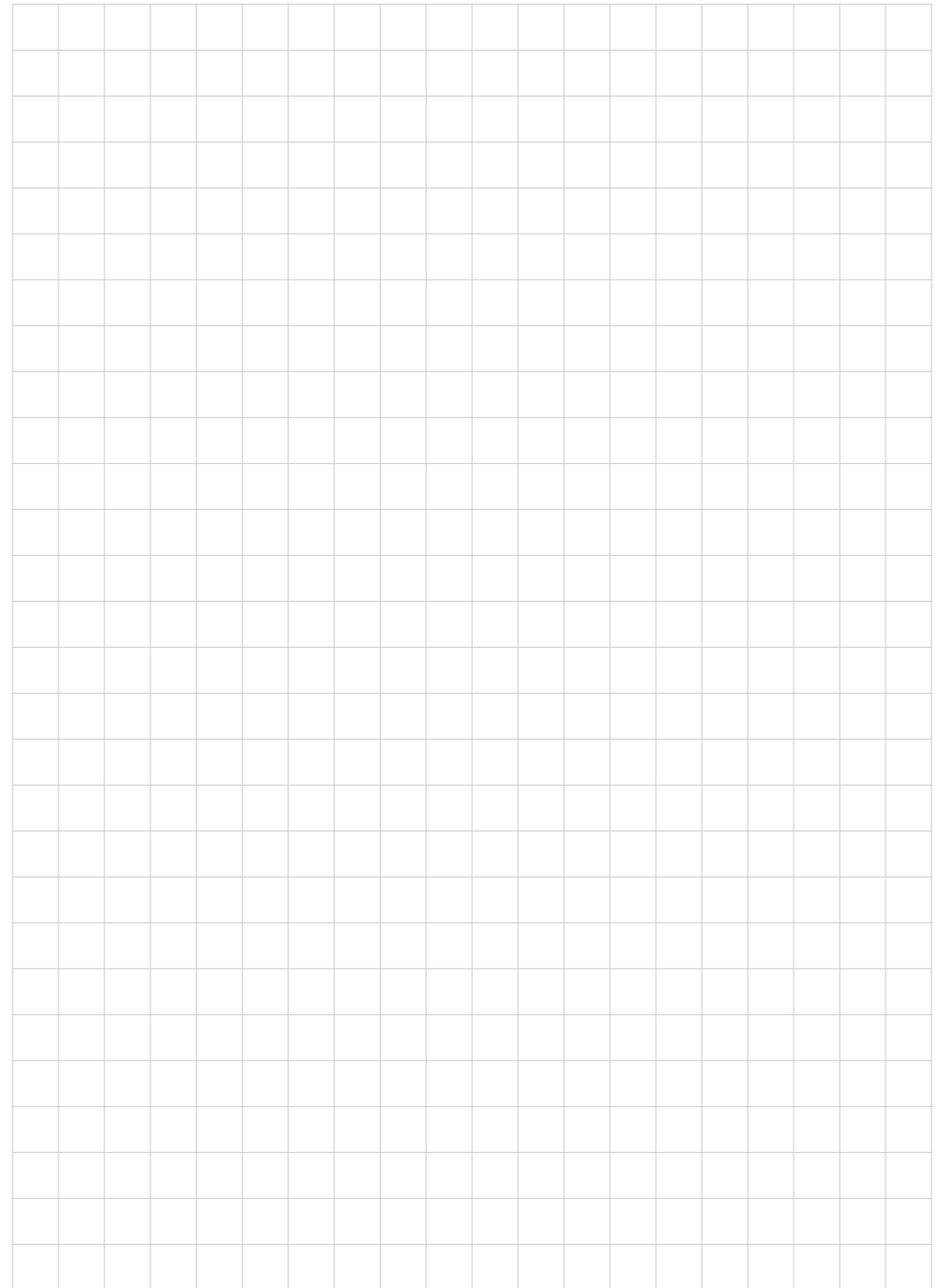
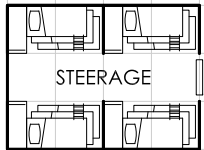
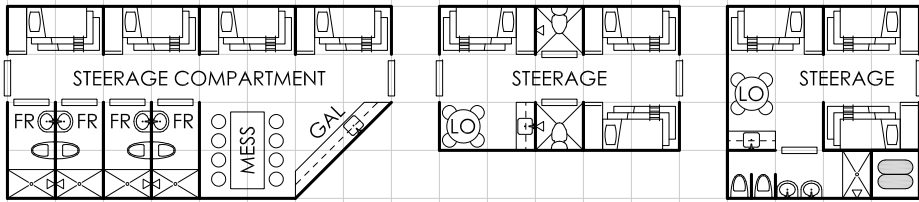
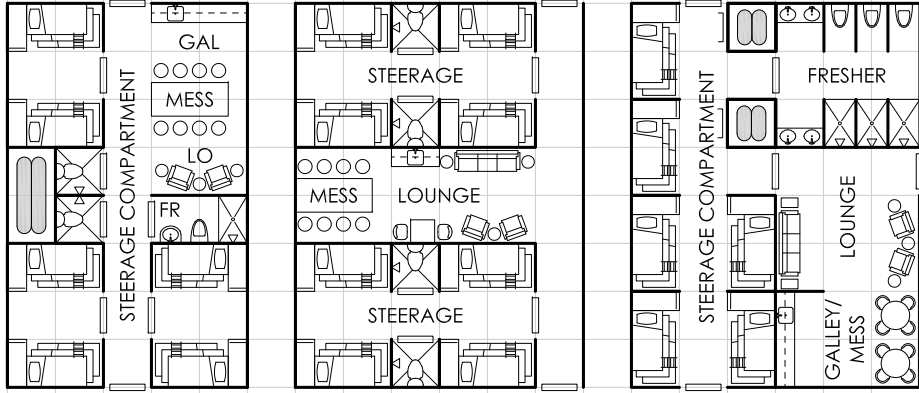
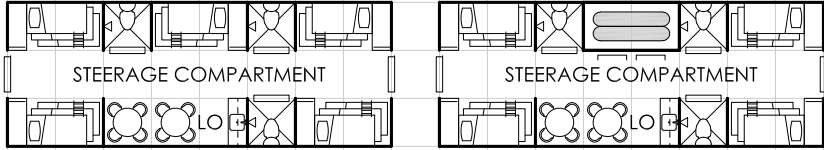

Weaponry

MANNED AND UNMANNED LASER TURRETS

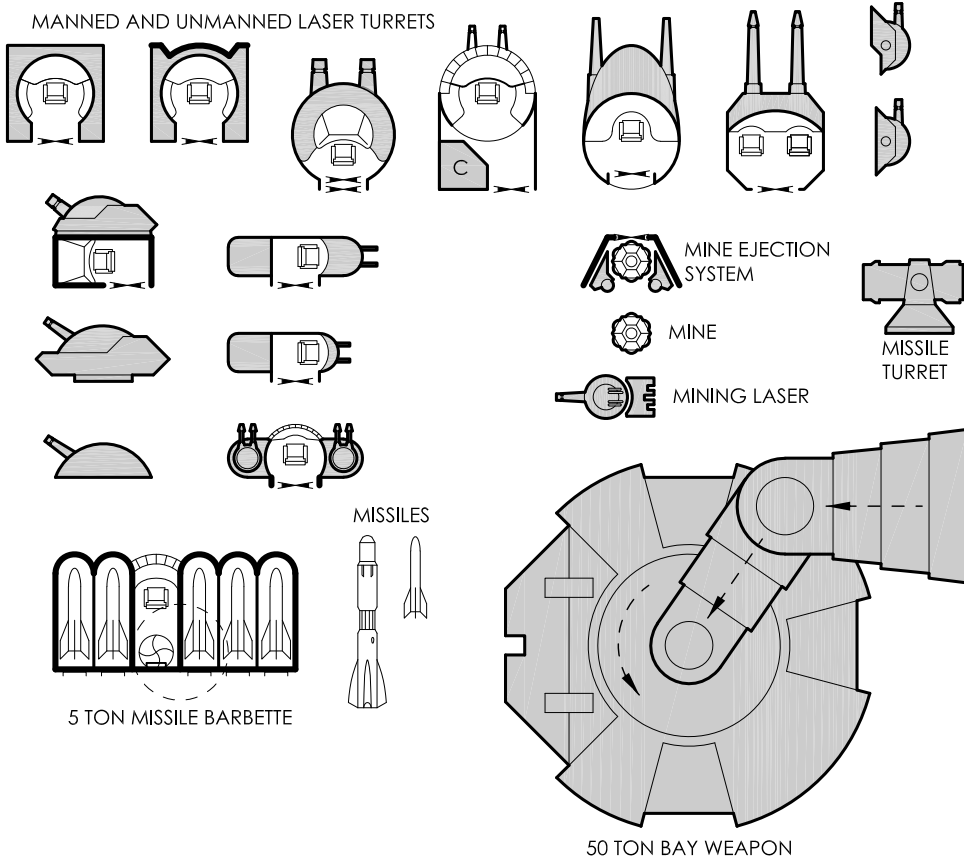

5 TON MISSILE BARBETTE

MISSILES

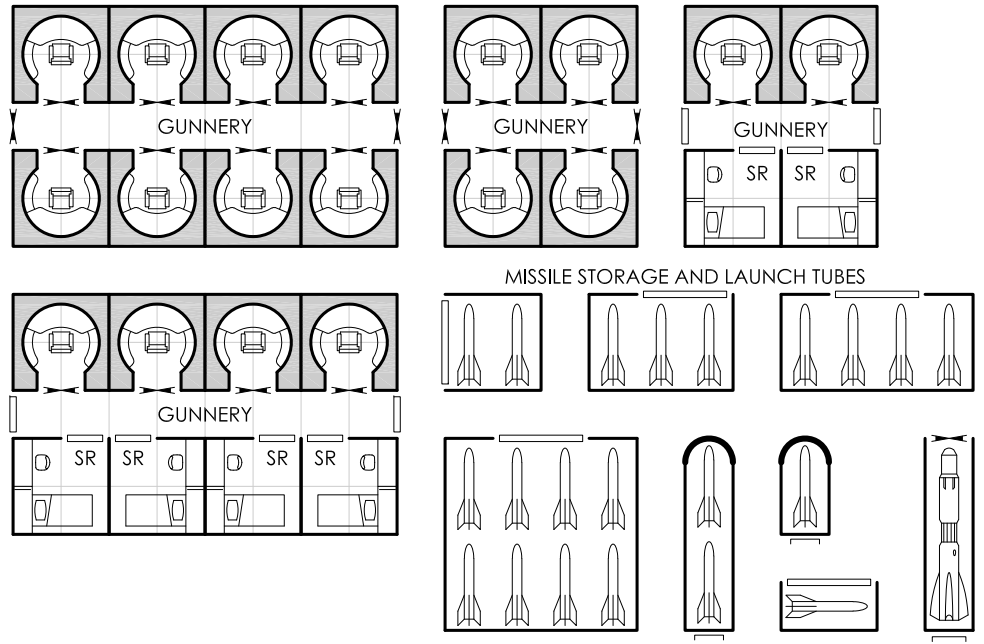
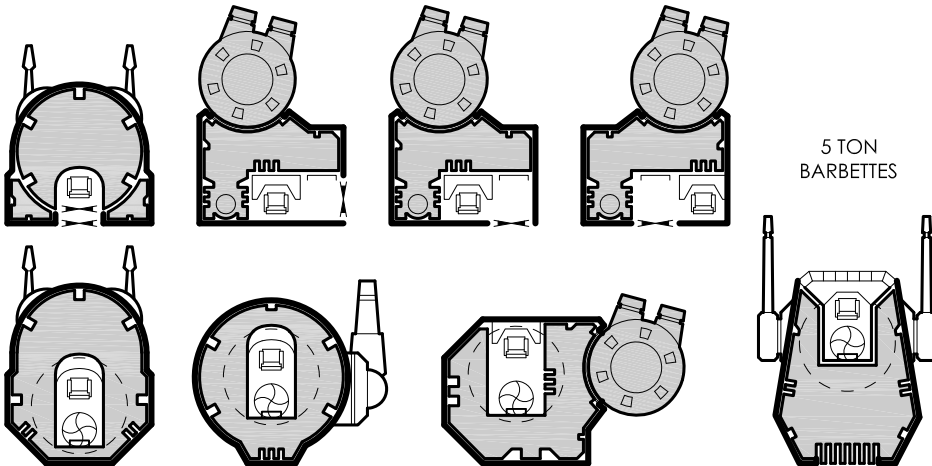

MANNED AND UNMANNED SANDCASTER TURRETS

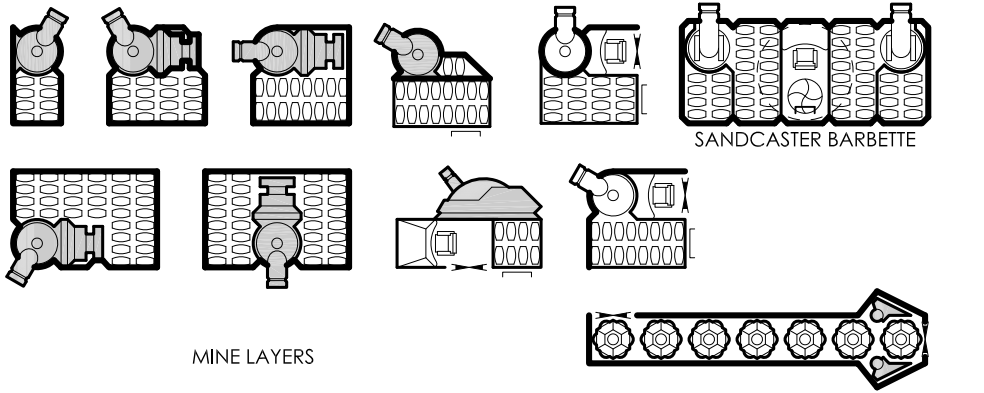

50 Ton Bay Weapons

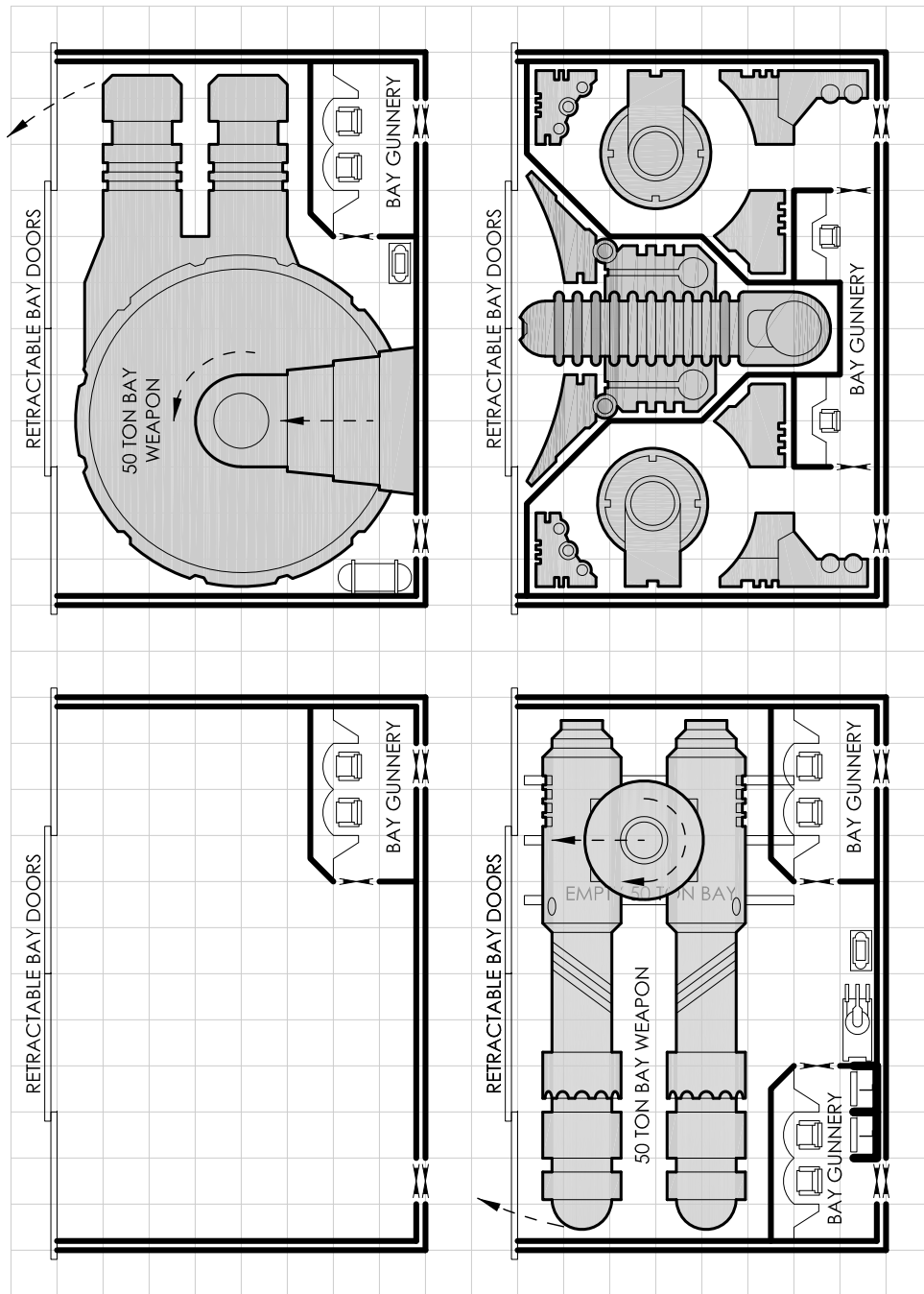

Sensors

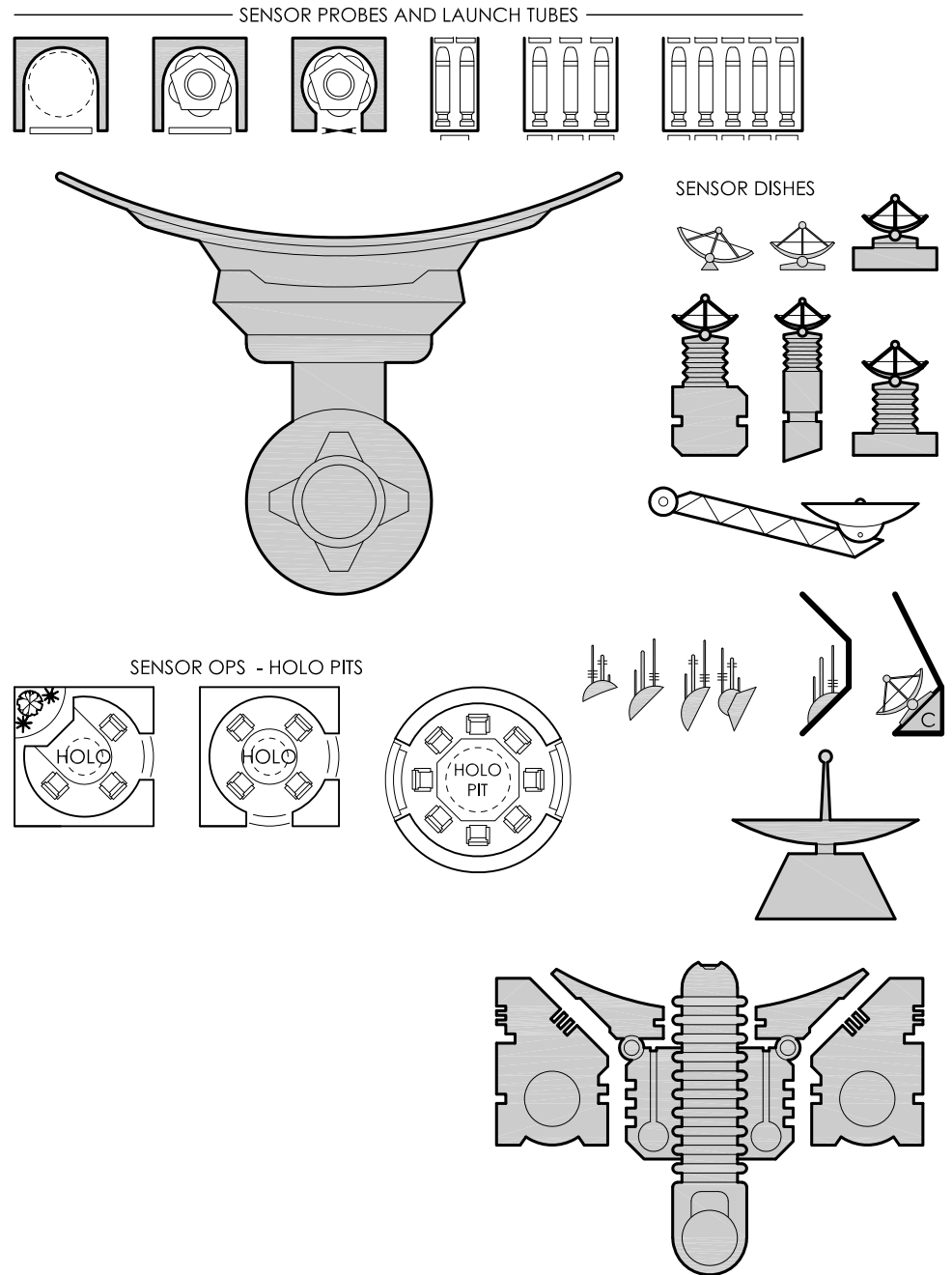

Miscellaneous Spaces

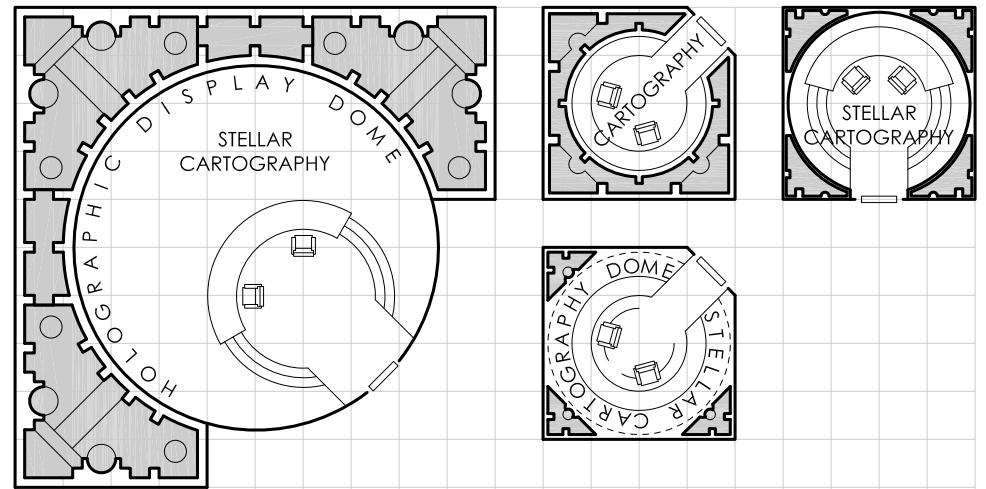
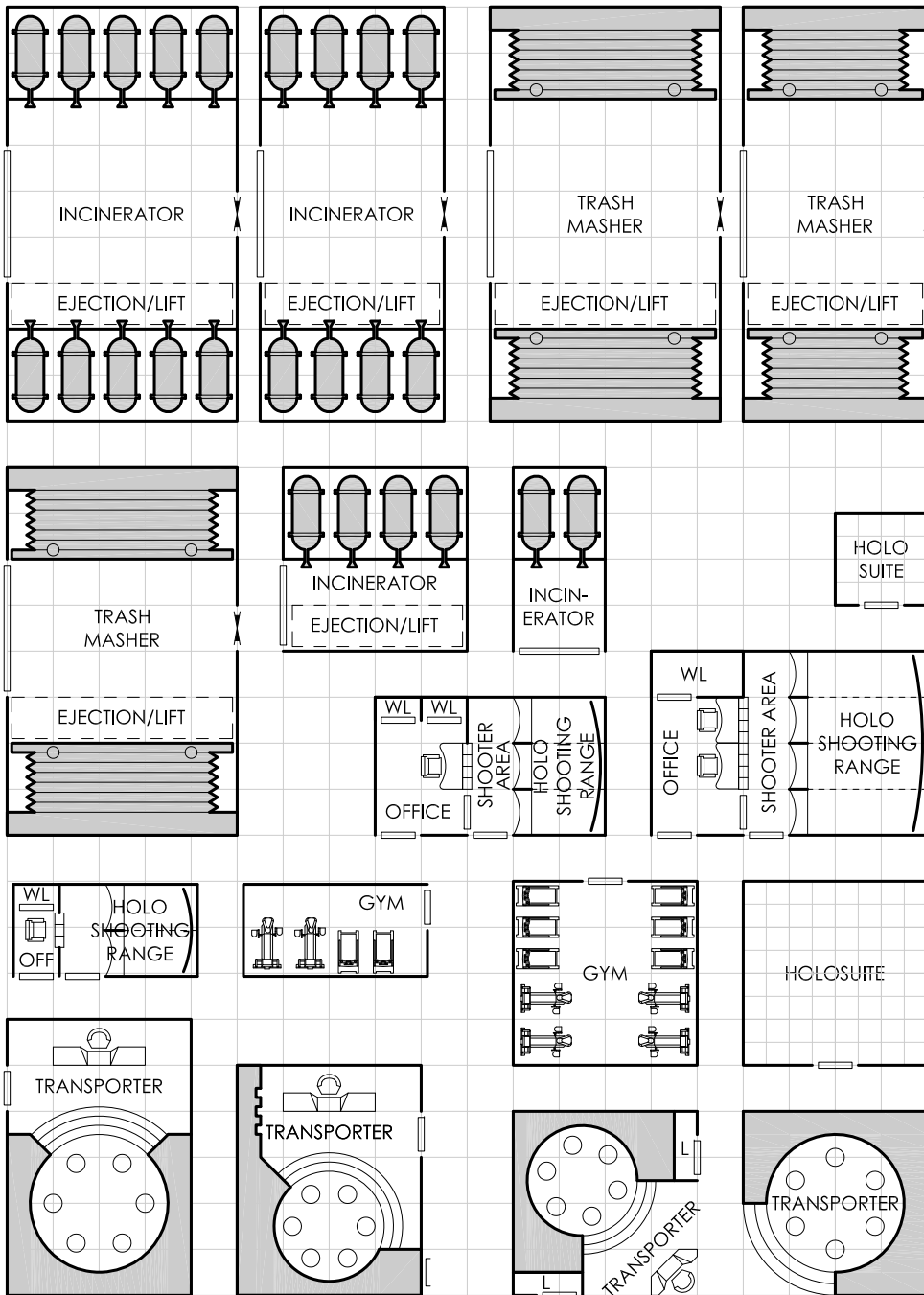

Furniture, Consoles, Equipment

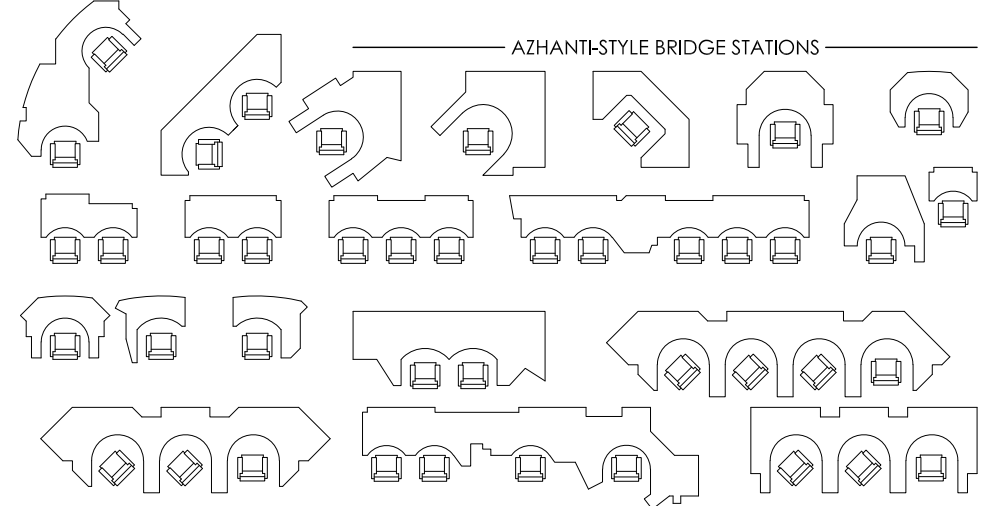
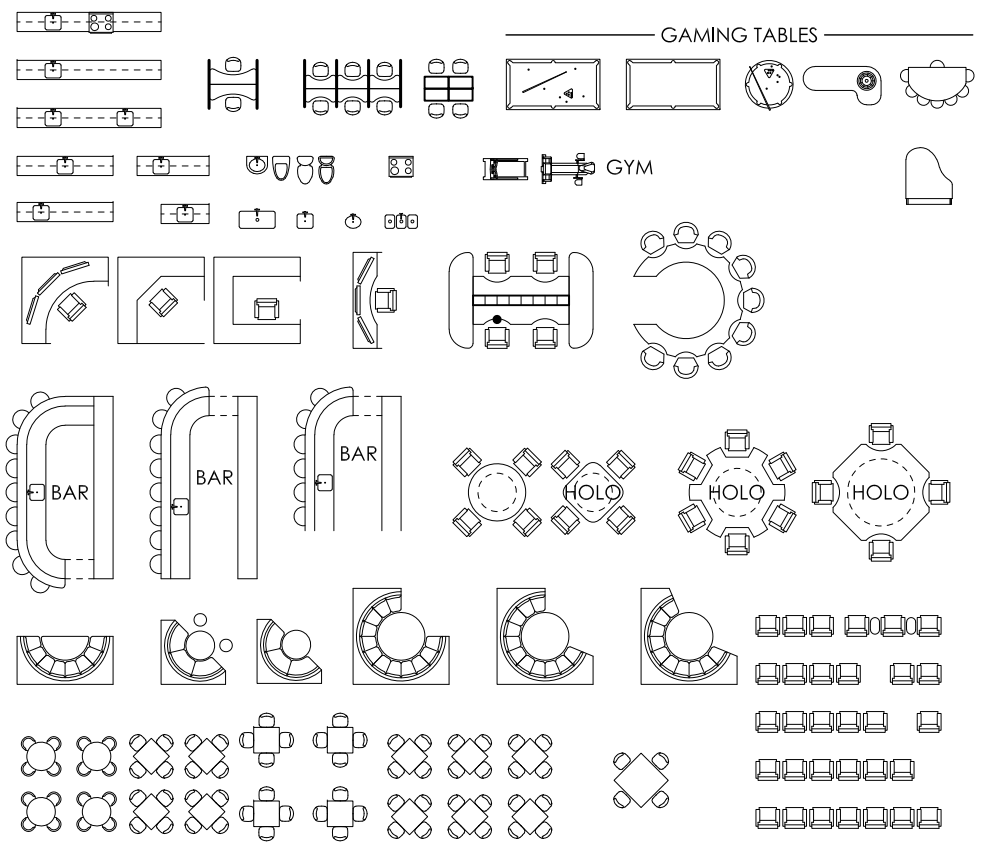
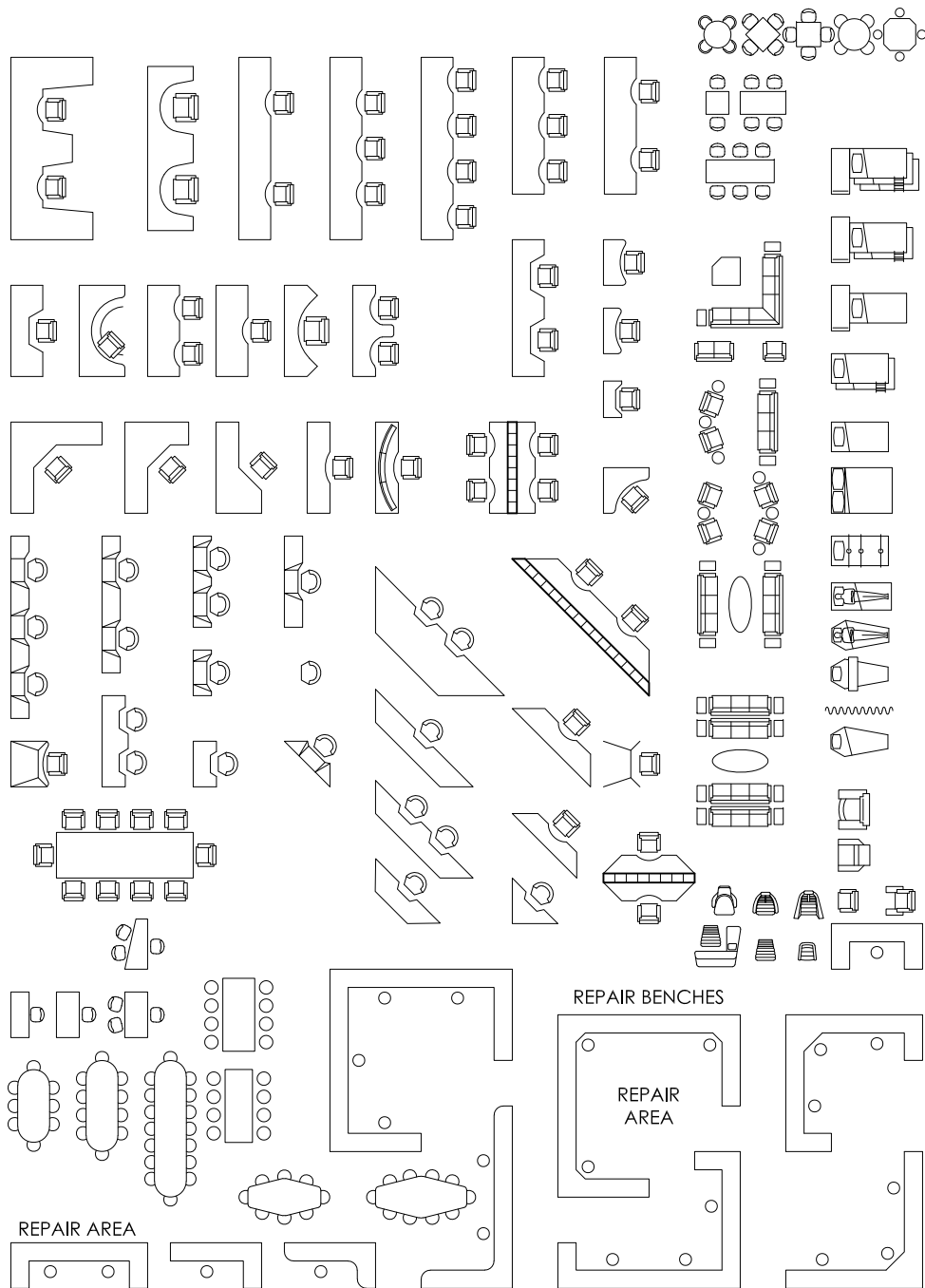

Landscape & Agriculture, Robots, Misc.

BUSHES AND TREES

LANDSCAPE AREAS

FOUNTAIN

BOULDERS

STONE PATH

BENCH

PLANTERS

ROBOT ALCOVES

LARGE ROBOT ALCOVES

ASSEMBLY LINE COMPONENTS

Doors, Windows, Misc.

DOORS & WINDOWS

EXTENDABLE AIRLOCKS

Empty Rooms

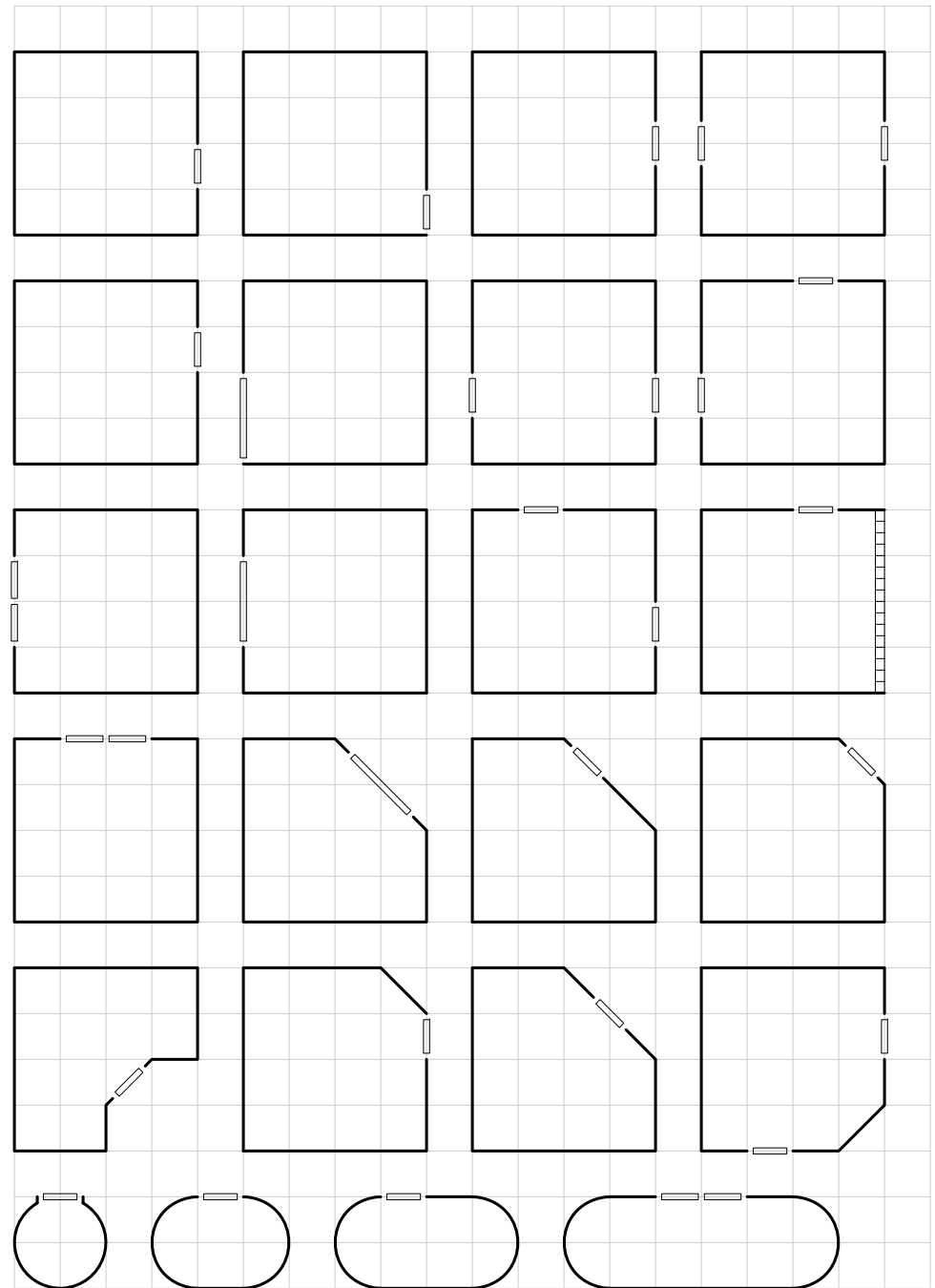
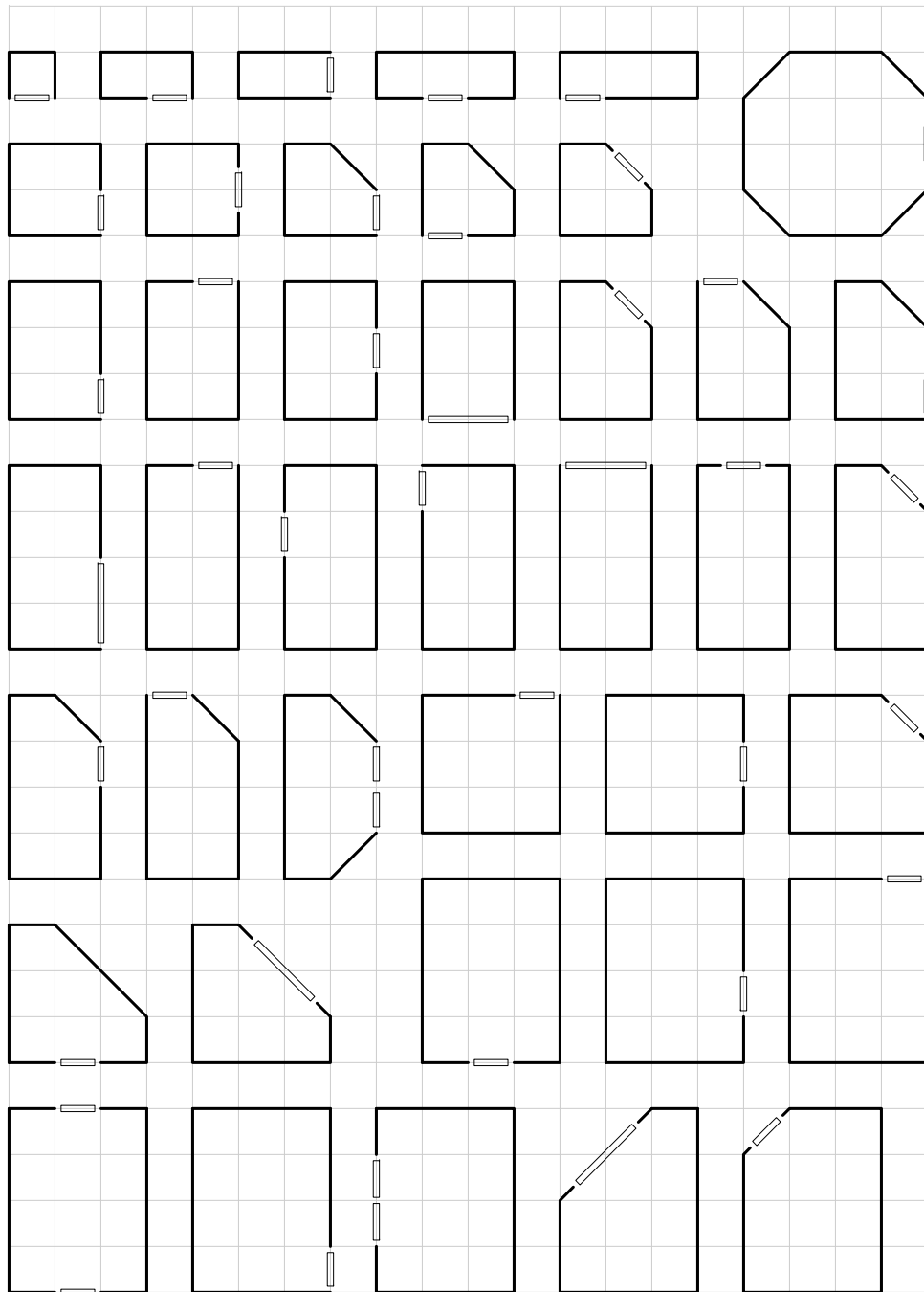

Empty Rooms

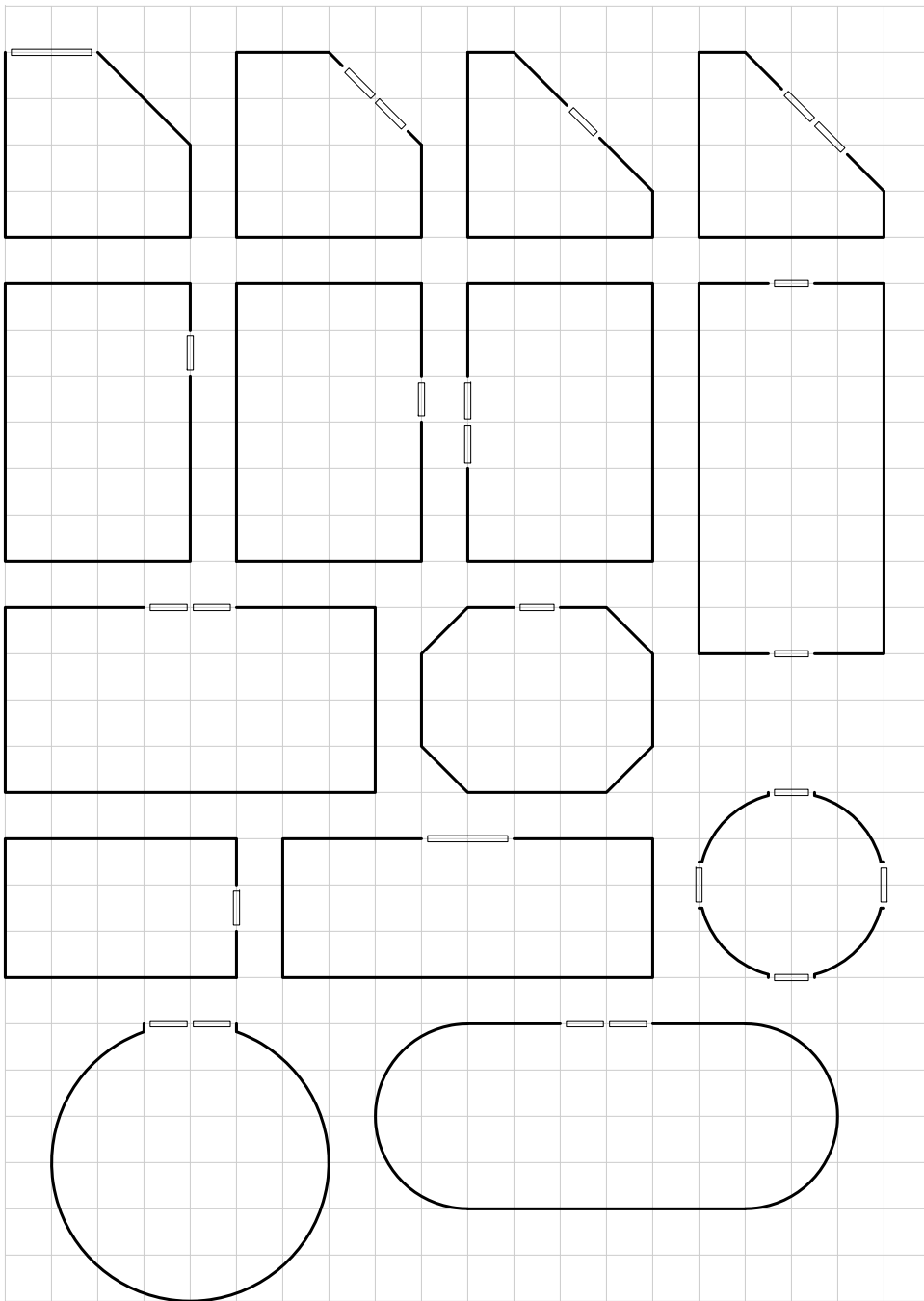

Corridors

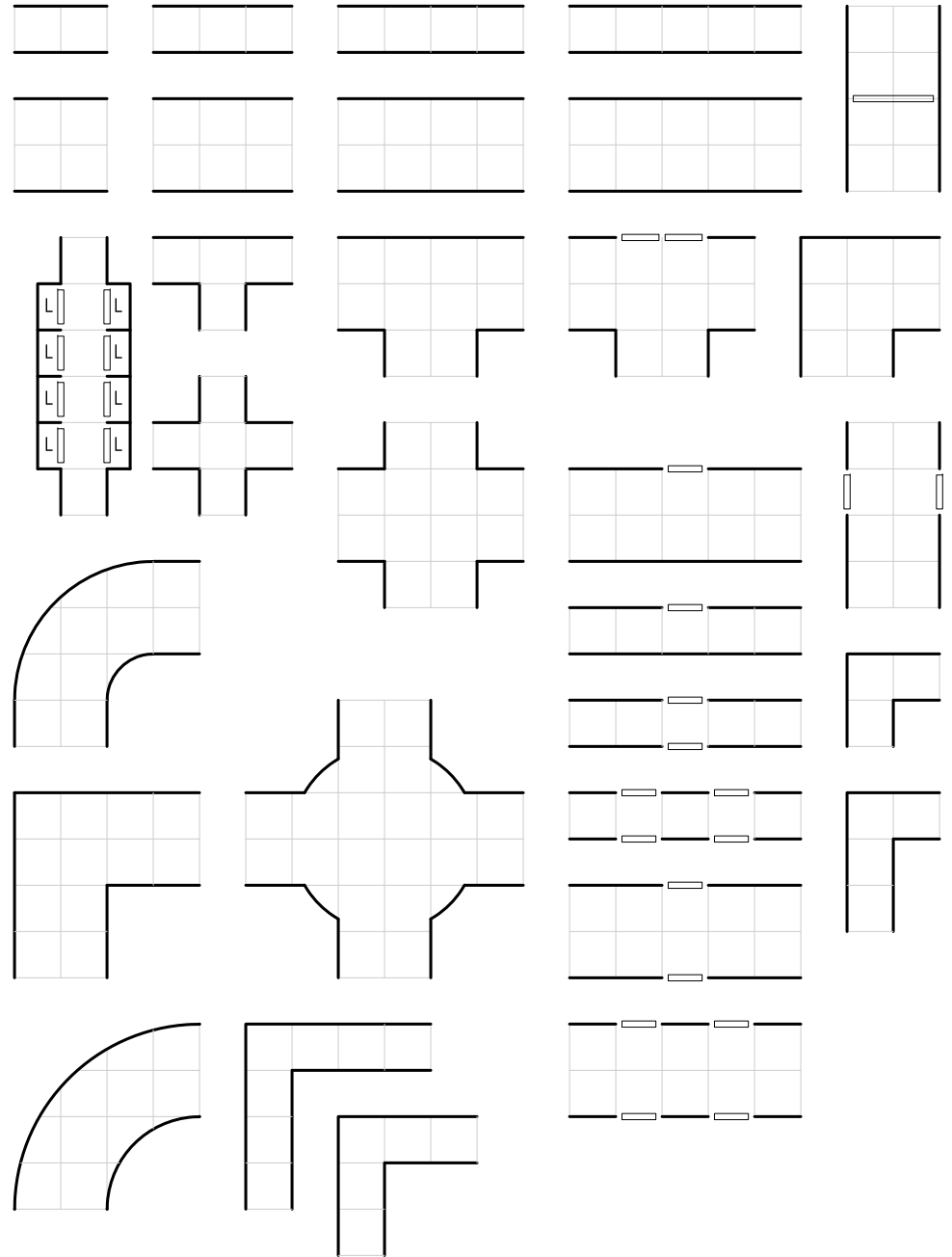

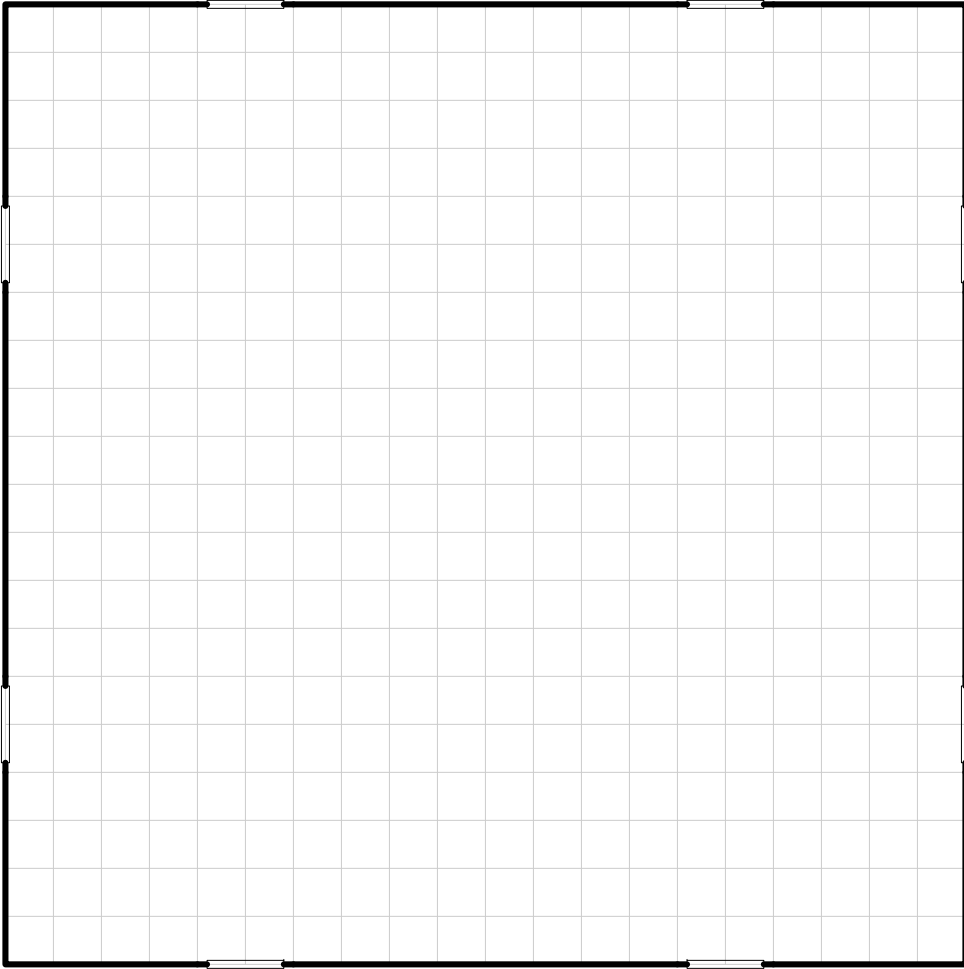
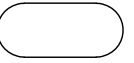
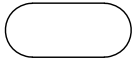

Notes:

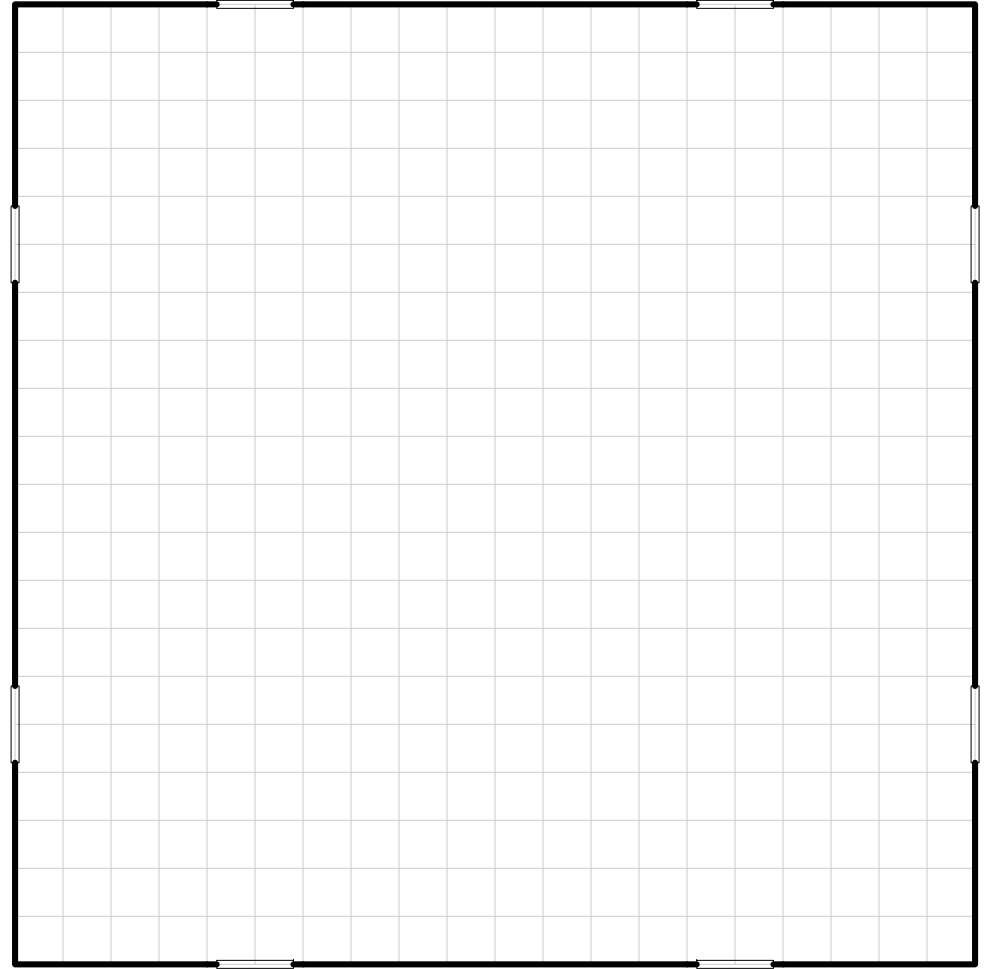

Notes:

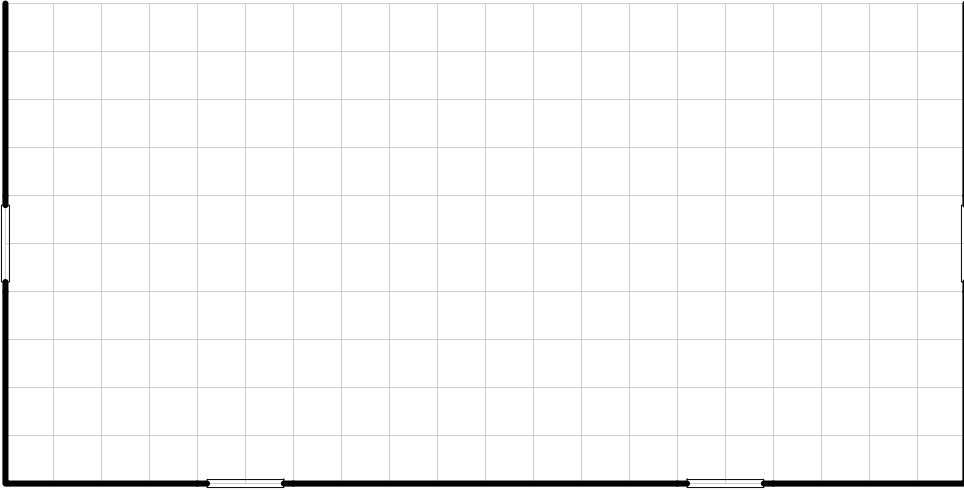
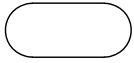

Notes:

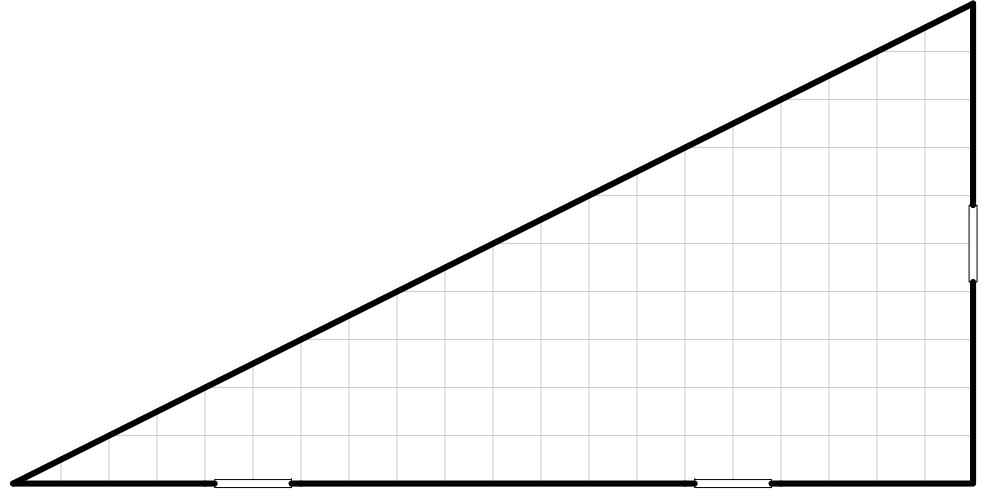
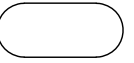

Notes:

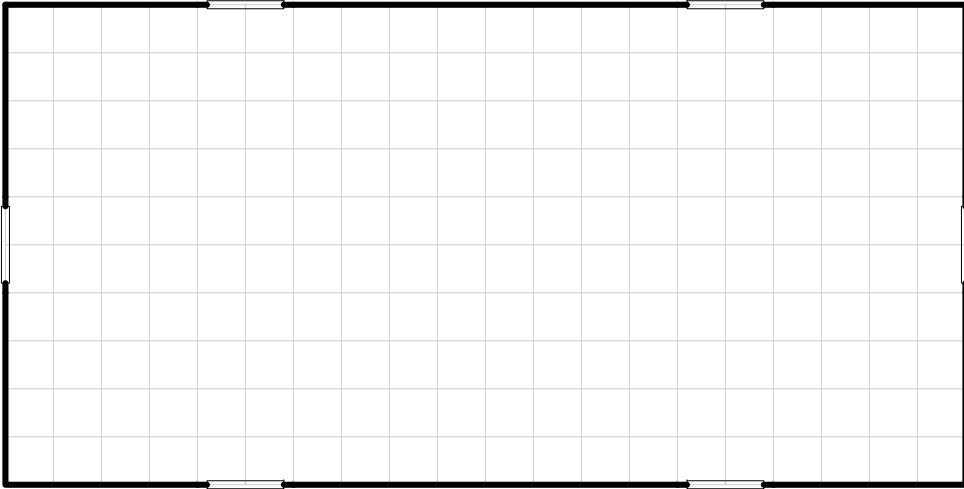
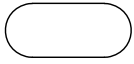

Notes:

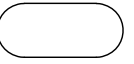

Notes:

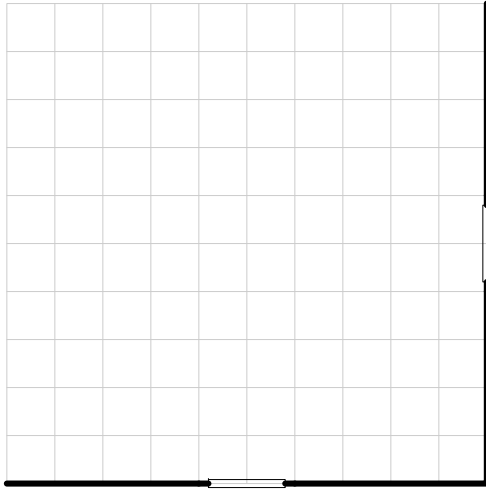
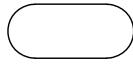

Notes:



Notes:

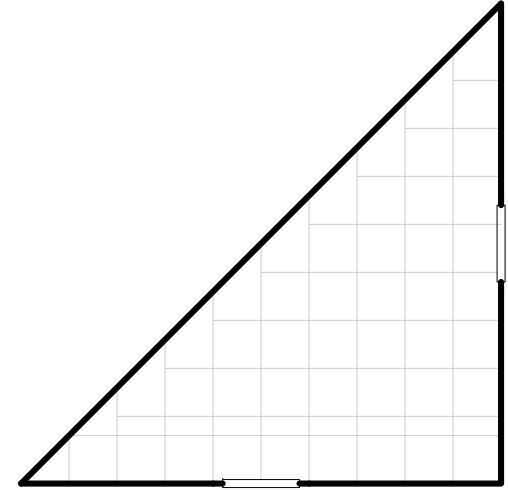
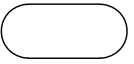

Notes:

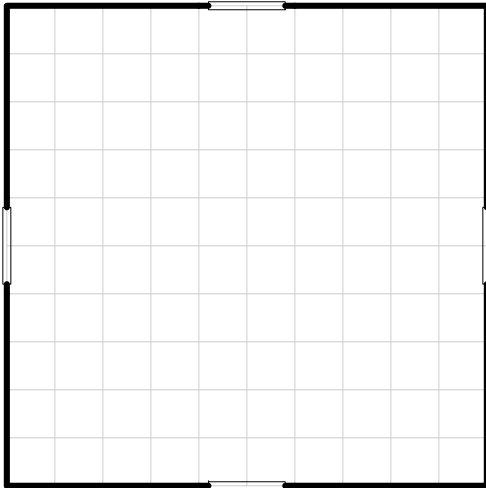
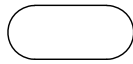

Notes:

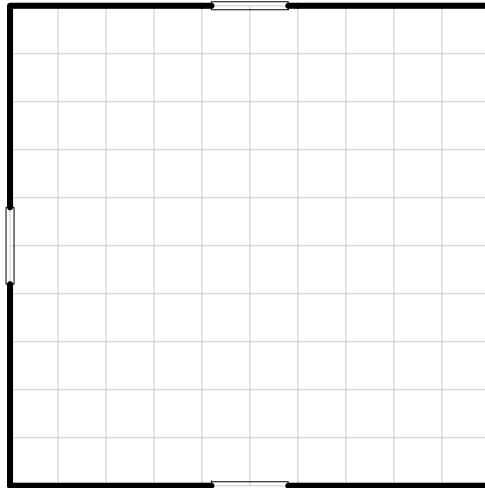

Notes:

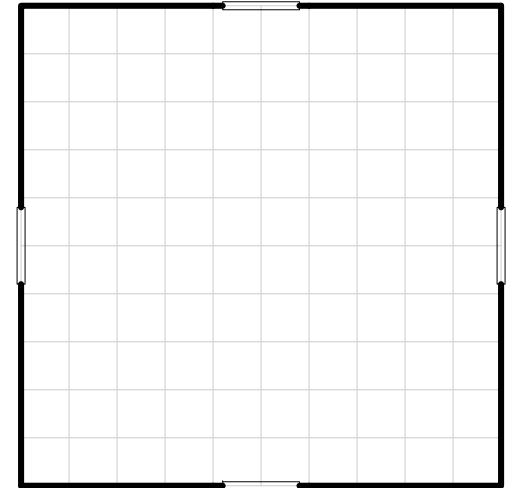
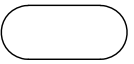

Notes:

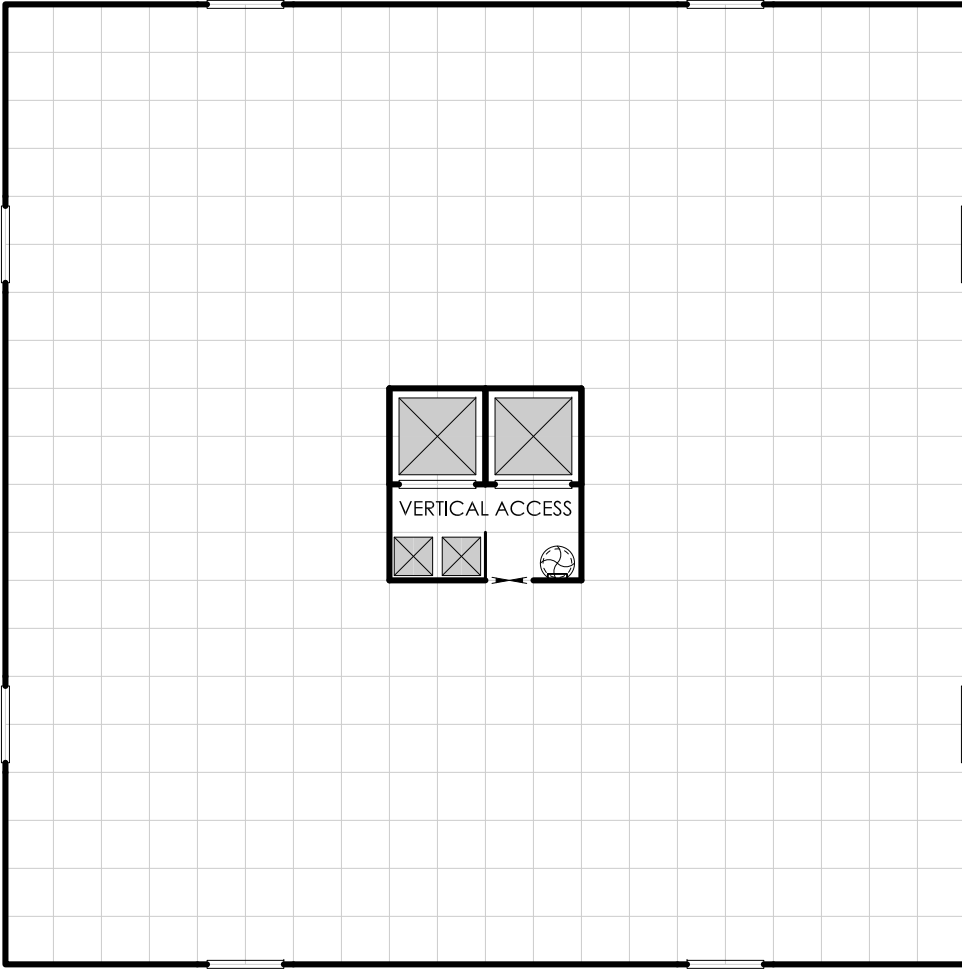
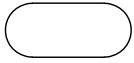

Notes:

- The core of this deck is for vertical access, allowing all designs created on this blank to allow continuous vertical movement.

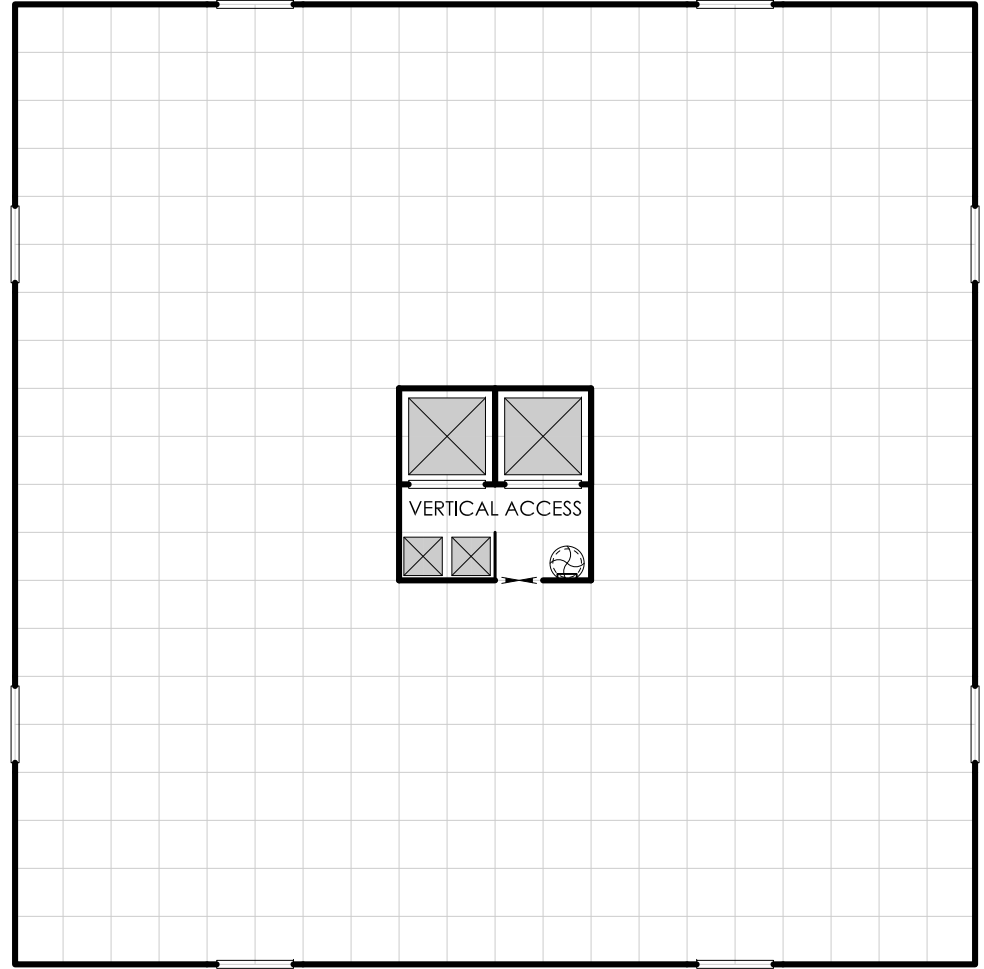
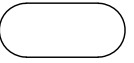

Notes:

- The core of this deck is for vertical access, allowing all designs created on this blank to allow continuous vertical movement.

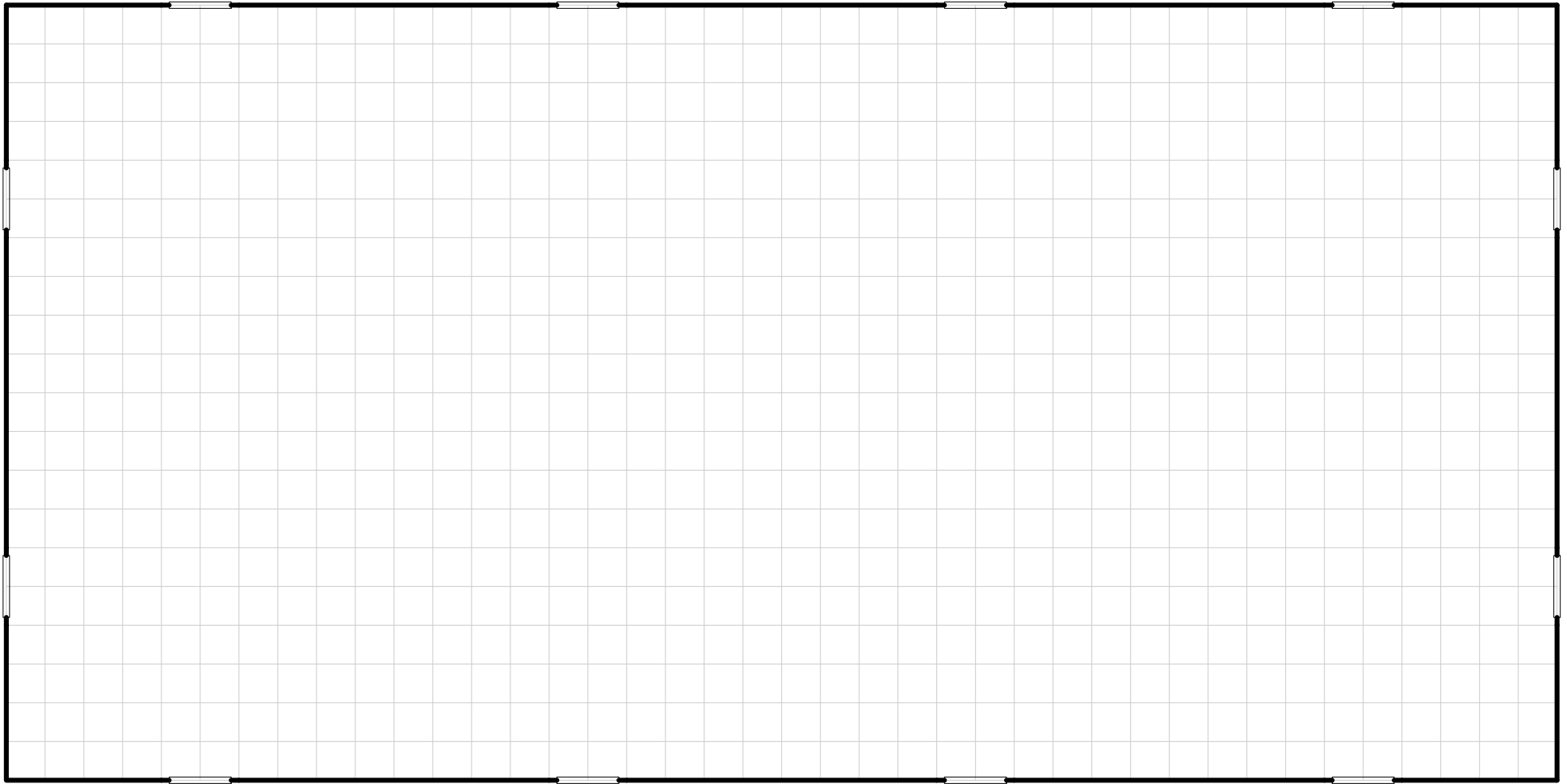

Notes:

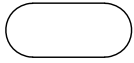

Notes:

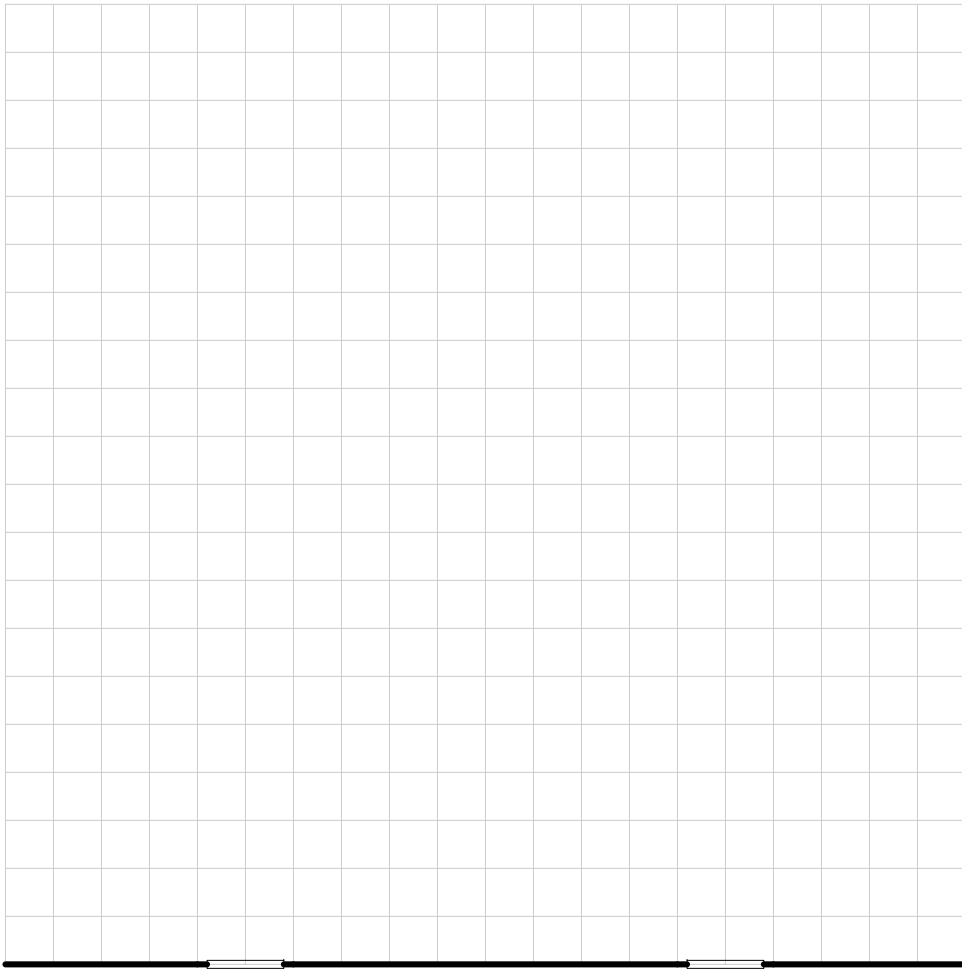
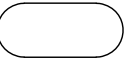
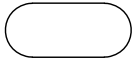

Notes:

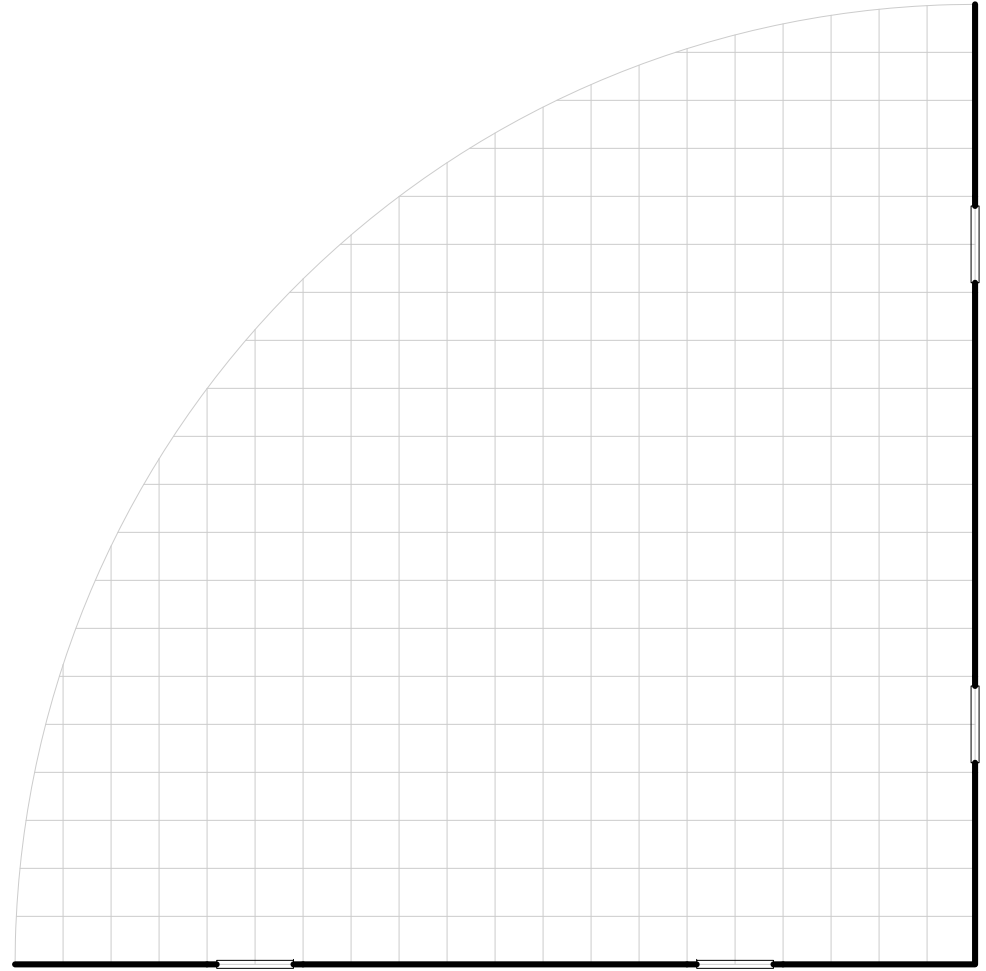

Notes:

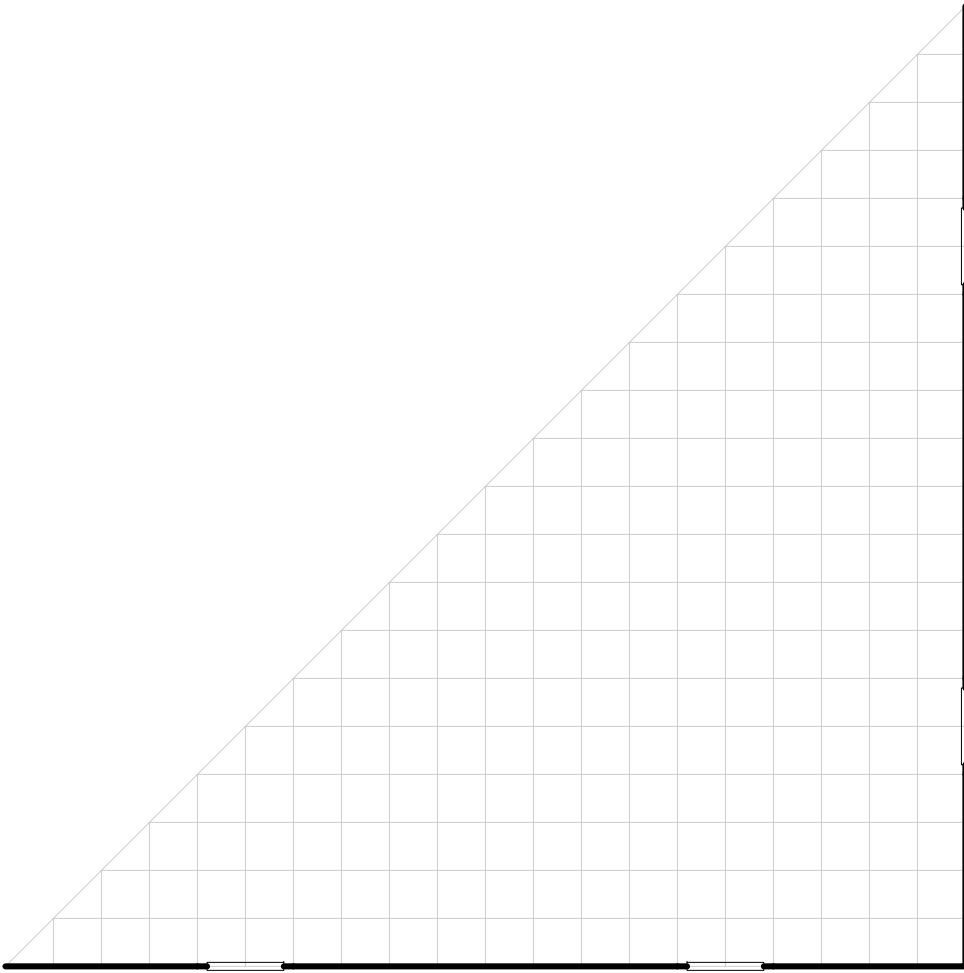
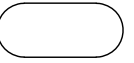
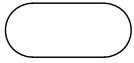

Notes:

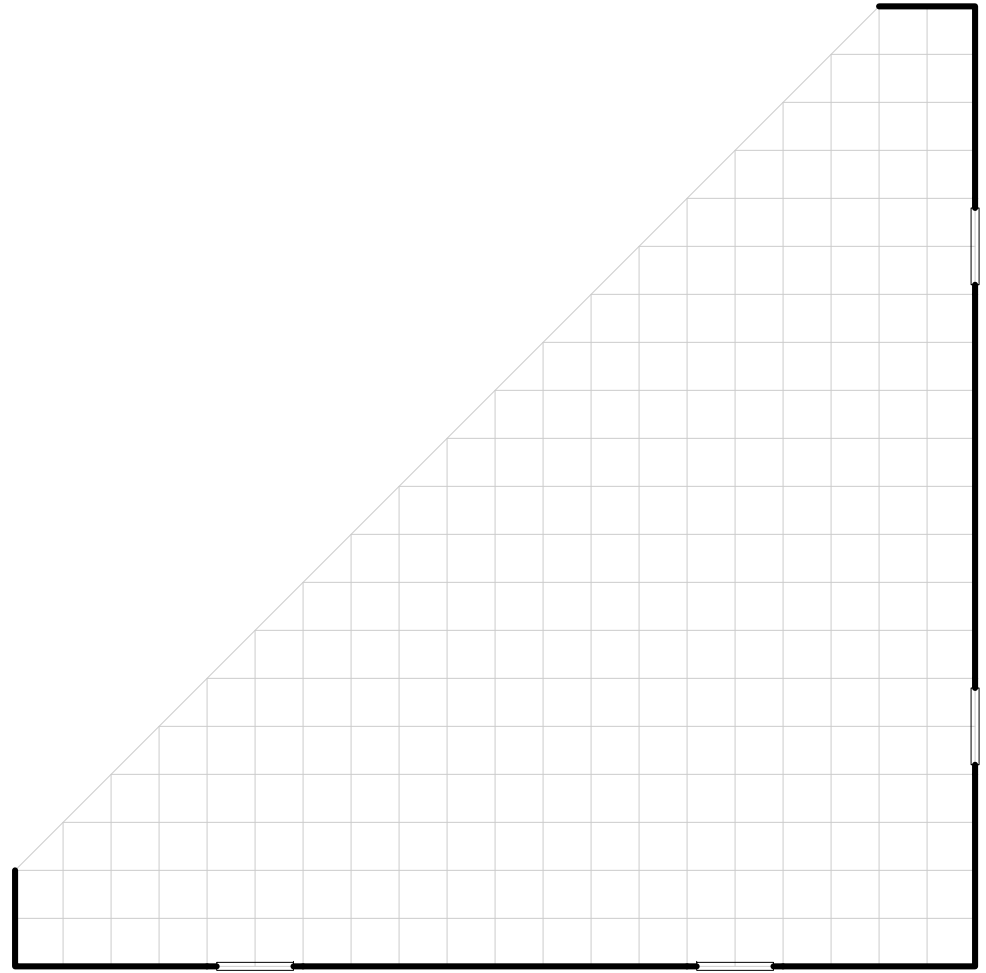

Notes:

